

TEST REPORT

Product Name : DataHub
Model Number : DataHub1000

Prepared for : SOLAX POWER NETWORK TECHNOLOGY (ZHEJIANG)
CO., LTD.

Address : No.288, Shizhu Road, Tonglu Economic Development
Zone, Tonglu City, Zhejiang Province 310000, P. R. China

Prepared by : EMTEK (NINGBO) CO., LTD.
Address : 1F Building 4, 1177#, Lingyun Road, Ningbo National
Hi-Tech Zone, Ningbo, Zhejiang, China.

Tel: +86-574-27907998
Fax: +86-574-27721538

Report Number : ENB2111250113E00501R
Date(s) of Tests : November 25, 2021 to December 03, 2021
Date of issue : December 03, 2021



TABLE OF CONTENT

Test Report Description	Page
1. DESCRIPTION OF STANDARDS AND RESULTS (EUT)	6
2. GENERAL INFORMATION	7
2.1. Description of Device (EUT)	7
2.2. Input / Output Ports.....	7
2.3. Independent Operation Modes	7
2.4. Test Manner	8
2.5. Description of Support Device	8
2.6. Description of Test Facility	9
2.7. Test Software	9
2.8. Measurement Uncertainty.....	10
3. MEASURING DEVICE AND TEST EQUIPMENT	11
3.1. For Power Line Conducted Emission Measurement.....	11
3.2. For Conducted Emissions at Telecommunications/network port Measurement.....	11
3.3. For Radiated Emission Measurement (Up to 1 GHz).....	11
3.4. For Radiated Emission Measurement (Above 1 GHz)	12
3.5. For Harmonic Current/Flicker Measurement	12
3.6. For Electrostatic Discharge Immunity Test	12
3.7. For RF Strength Susceptibility Test	13
3.8. For Electrical Fast Transient /Burst Immunity Test	13
3.9. For Surge Immunity Test.....	14
3.10. For Injected Current Susceptibility Test	14
3.11. For Voltage Dips and Interruptions Test.....	14
4. CONDUCTED EMISSIONS FROM THE AC MAINS POWER PORTS	15
4.1. Block Diagram of Test Setup	15
4.2. Limits.....	15
4.3. Test Procedure.....	15
4.4. Measuring Results	16
5. ASYMMETRIC MODE CONDUCTED EMISSIONS AT WIRED NETWORK PORTS	21
5.1. Block Diagram of Test Setup	21
5.2. Limits.....	21
5.3. Test Procedure.....	21
5.4. Measuring Results	22
6. RADIATED EMISSION MEASUREMENT (UP TO 1GHZ)	25
6.1. Block Diagram of Test Setup	25
6.2. Radiated Limit.....	25
6.3. Test Procedure.....	25
6.4. Measuring Results	26
7. RADIATED EMISSION MEASUREMENT (ABOVE 1GHZ)	31
7.1. Block Diagram of Test Setup	31
7.2. Radiated Limit.....	31
7.3. Test Procedure.....	32
7.4. Measuring Results	32
8. HARMONIC CURRENT EMISSION MEASUREMENT	34
8.1. Block Diagram of Test Setup	34
8.2. Standard Limits	34
8.3. Test Procedure.....	35
8.4. Test Results	35
9. VOLTAGE FLUCTUATION AND FLICKER MEASUREMENT	39
9.1. Block Diagram of Test Setup	39

9.2. Standard Limits	39
9.3. Test Procedure.....	39
9.4. Test Results	39
10. IMMUNITY GENERAL PERFORMANCE CRITERIA DESCRIPTION	41
11. ELECTROSTATIC DISCHARGE	42
11.1. Test Specification	42
11.2. Block Diagram of Test Setup	42
11.3. Test Procedure.....	42
11.4. Test Results	43
12. CONTINUOUS RF ELECTROMAGNETIC FIELD DISTURBANCES.....	44
12.1. Test Specification	44
12.2. Block Diagram of Test Setup	44
12.3. Test procedure	44
12.4. Test results	45
13. ELECTRICAL FAST TRANSIENTS/BURST	46
13.1. Test Specification	46
13.2. Block Diagram of Test Setup	46
13.3. Test Procedure.....	47
13.4. Test Results	47
14. SURGES	48
14.1. Test Specification	48
14.2. Block Diagram of Test Setup	48
14.3. Test Procedure.....	48
14.4. Test results	49
15. CONTINUOUS INDUCED RF DISTURBANCES	50
15.1. Test Specification	50
15.2. Block Diagram of Test Setup	50
15.3. Test Procedure.....	50
15.4. Test results	51
16. POWER FREQUENCY MAGNETIC FIELD.....	52
16.1. Test Specification	52
16.2. Block Diagram of Test Setup	52
16.3. Test Procedure.....	52
16.4. Test Results	52
17. VOLTAGE DIPS AND INTERRUPTIONS	53
17.1. Test Specification	53
17.2. Block Diagram of Test Setup	53
17.3. Test Procedure.....	53
17.4. Test results	54
18. PHOTOGRAPHS	55
18.1. Photo of Conducted Emission Measurement	55
18.2. Photo of Conducted Emissions at Telecommunications/network port Measurement.....	56
18.3. Photo of Radiation Emission Measurement (Up to 1GHz)	57
18.4. Photo of Radiation Emission Measurement (Above 1GHz).....	58
18.5. Photo of Harmonic and Flicker Measurement	59
18.6. Photo of Electrostatic Discharge Test	59
18.7. Photo of RF Field Strength Susceptibility Test.....	60
18.8. Photo of Electrical Fast Transient /Burst Test.....	60
18.9. Photo of Surge Test	61
18.10. Photo of Injected Currents Susceptibility Test	61
18.11. Photo of Voltage Dips and Interruption Immunity Test.....	62

APPENDIX (Photos of the EUT) (7 Pages)

TEST REPORT DESCRIPTION

Applicant : SOLAX POWER NETWORK TECHNOLOGY (ZHEJIANG) CO., LTD.
Manufacturer : SOLAX POWER NETWORK TECHNOLOGY (ZHEJIANG) CO., LTD.
Trade Mark : SolaX Power
EUT : DataHub
Model Number : DataHub1000
Input Voltage : AC 100-240V, 50/60Hz, 24W

Measurement Procedure Used:

EN 55032:2015+A11:2020

EN IEC 61000-3-2:2019

EN 61000-3-3:2013/A1:2019

EN 55035:2017+A11:2020

(IEC 61000-4-2:2008, IEC 61000-4-3:2006+A1:2007+A2:2010, IEC 61000-4-4:2012,
IEC 61000-4-5:2005, IEC 61000-4-6:2008, IEC 61000-4-8:2009, IEC 61000-4-11:2004)

The device described above is tested by EMTEK (NINGBO) CO., LTD. to determine the maximum emission levels emanating from the device and the severe levels of the device can endure and its performance criterion. The measurement results are contained in this test report and EMTEK (NINGBO) CO., LTD. is assumed full of responsibility for the accuracy and completeness of these measurements. Also, this report shows that the EUT (Equipment Under Test) is technically compliant with the EN 55032, EN IEC 61000-3-2, EN 61000-3-3, EN 55035 requirements.

This report applies to above tested sample only and shall not be reproduced in part without written approval of EMTEK (NINGBO) CO., LTD.

Date of Test : November 25, 2021 to December 03, 2021

Prepared by : *June Gao*
June Gao/Engineer

Reviewer : *Ade Wang*
Ade Wang/Supervisor

Approved & Authorized Signer : *Tony Wei*
Tony Wei/Manager



Modified Information

Version	Report No.	Revision Date	Summary
	ENB2111250113E00501R	/	Original Report



1. DESCRIPTION OF STANDARDS AND RESULTS (EUT)

EMISSION				
Description of Test Item		Standard	Limits	Results
Conducted Emissions From the AC Mains Power Ports		EN 55032:2015+A11:2020	Class B	Pass
Asymmetric mode conducted emissions	Wired network ports	EN 55032:2015+A11:2020	Class B	Pass
	Optical fibre ports	EN 55032:2015+A11:2020	Class B	N/A
	Broadcast receiver tuner ports	EN 55032:2015+A11:2020	Class B	N/A
	Antenna ports	EN 55032:2015+A11:2020	Class B	N/A
Conducted differential voltage emissions	TV broadcast receiver tuner ports	EN 55032:2015+A11:2020	Class B	N/A
	RF modulator output ports	EN 55032:2015+A11:2020	Class B	N/A
	FM broadcast receiver tuner ports	EN 55032:2015+A11:2020	Class B	N/A
Radiated emissions at frequencies up to 1 GHz		EN 55032:2015+A11:2020	Class B	Pass
Radiated emissions at frequencies above 1 GHz		EN 55032:2015+A11:2020	Class B	Pass
Radiated emissions from FM receivers		EN 55032:2015+A11:2020	Table A.6	N/A
Outdoor units of home satellite receiving systems		EN 55032:2015+A11:2020	Table A.7	N/A
Harmonic Current Emissions		EN IEC 61000-3-2:2019	Class A	Pass
Voltage Fluctuation and Flicker		EN 61000-3-3:2013/A1:2019	Section 5	Pass
IMMUNITY(EN 55035:2017+A11:2020)				
Description of Test Item		Basic Standard	Performance Criteria	Results
Electrostatic Discharge	Enclosure ports	IEC 61000-4-2:2008	B	Pass
Continuous RF electromagnetic field disturbances	Enclosure ports	IEC 61000-4-3:2006+A1:2007+A2:2010	A	Pass
Electrical fast transients/burst	AC mains power ports	IEC61000-4-4:2012	B	Pass
	Analogue/digital data ports		B	Pass
	DC network power ports		B	N/A
Surges	AC mains power ports	IEC 61000-4-5:2005	B	Pass
	Analogue/digital data ports for unshielded symmetrical		C	Pass
	Analogue/digital data ports for coaxial or shielded		B	N/A
	DC network power ports		B	N/A
Continuous induced RF disturbances	AC mains power ports	IEC 61000-4-6:2008	A	Pass
	Analogue/digital data ports		A	Pass
	DC network power ports		A	N/A
Power frequency magnetic field	Enclosure ports	IEC 61000-4-8:2009	A	N/A
Voltage dips and interruptions	AC mains power ports	IEC 61000-4-11:2004	B,C	Pass
Broadband impulsive conducted disturbances	Analogue/digital data ports	\	N/A	N/A
Note: N/A is an abbreviation for Not Applicable.				

2. GENERAL INFORMATION

2.1. Description of Device (EUT)

EUT : DataHub

Model Number : DataHub1000

Test Voltage : AC 230V/50Hz, AC 120V/60Hz

AC Adapter : M/N: ABT020120A
Input: AC 100-240V, 50/60Hz, 1.5A
Output: DC 12V, 2A, 24W

Highest Frequency : 2480 MHz

Sample Number : ENB2111250113E005-1-1

Applicant : SOLAX POWER NETWORK TECHNOLOGY (ZHEJIANG) CO., LTD.

Address : No.288, Shizhu Road, Tonglu Economic Development Zone, Tonglu City, Zhejiang Province 310000, P. R. China

Manufacturer : SOLAX POWER NETWORK TECHNOLOGY (ZHEJIANG) CO., LTD.

Address : No.288, Shizhu Road, Tonglu Economic Development Zone, Tonglu City, Zhejiang Province 310000, P. R. China

Date of Received : November 25, 2021

Date of Test : November 25, 2021 to December 03, 2021

2.2. Input / Output Ports

Port #	Name	Type*	Cable Max. >3m	Cable Shielded	Comments
1	Enclosure	N/E	--	--	None
2	RS485	A/D	--	--	None
3	Net Port	A/D	--	--	None

*Note: Use abbreviations:

AC= AC Power port

DC= DC Power port

N/E= Non-Electrical

A/D=Analogue/digital data port (signal/control port, antenna port, wired network port, broadcast receiver tuner port, optical fibre port)

2.3. Independent Operation Modes

A. ON

2.4. Test Manner

Test Items	Test Voltage	Operation Modes	Worst case
Conducted disturbance at mains Terminals	AC 230V/50Hz AC 120V/60Hz	Mode A	Mode A
Asymmetric mode conducted emissions	AC 230V/50Hz AC 120V/60Hz	Mode A	Mode A
Radiated emissions at frequencies up to 1 GHz	AC 230V/50Hz AC 120V/60Hz	Mode A	Mode A
Radiated emissions at frequencies above 1 GHz	AC 230V/50Hz AC 120V/60Hz	Mode A	Mode A
Harmonic Current Emissions	AC 230V/50Hz	Mode A	Mode A
Voltage Fluctuation and Flicker	AC 230V/50Hz	Mode A	Mode A
Electrostatic Discharge	AC 230V/50Hz	Mode A	Mode A
Continuous RF Electromagnetic Field Disturbances	AC 230V/50Hz	Mode A	Mode A
Electrical Fast Transient / Burst	AC 230V/50Hz	Mode A	Mode A
Surges	AC 230V/50Hz	Mode A	Mode A
Continuous induced RF disturbances	AC 230V/50Hz	Mode A	Mode A
Voltage dips and interruptions	AC 230V/50Hz AC 230V/60Hz	Mode A	Mode A

2.5. Description of Support Device

Notebook : Manufacturer: LENOVO
M/N: T430s
S/N: R9RK4YK

Notebook : Manufacturer: ASUS
M/N: FX80G
S/N: J7NRCX03D694281

Wireless router : Manufacturer: TP-LINK
M/N: TL-WR886N
S/N: 1156004013356

2.6. Description of Test Facility

Site Description
EMC Lab.

: **Accredited by CNAS**

The Certificate Registration Number is L6666.

The Laboratory has been assessed and proved to be in compliance with CNAS-CL01:2018 (identical to ISO/IEC 17025:2017)

Accredited by FCC

Designation Number: CN1302

Test Firm Registration Number: 436491

Accredited by A2LA

The certificate is valid until May 31, 2023

Accredited by Industry Canada

The Conformity Assessment Body Identifier is CN0114

Name of Firm : EMTEK (NINGBO) CO., LTD.

Site Location : 1F Building 4, 1177#, Lingyun Road, National Hi-Tech Zone, Ningbo, Zhejiang, China

2.7. Test Software

Item	Software
Conducted Emission	: EZ-EMC (Ver. CON-03A1)
Radiated Emission	: EZ-EMC (Ver. EMEC-3A1)

2.8. Measurement Uncertainty

Test Item	Uncertainty
Conducted Emission Uncertainty	: 2.08dB (9 k-150 kHz) 2.40dB (150 k-30 MHz)
Radiated Emission Uncertainty (3m Chamber)	: 4.06dB (Polarize: H) (30MHz-1000MHz) 4.04dB (Polarize: V) (30MHz-1000MHz) 4.82dB (Polarize: H) (1~18GHz) 4.80dB (Polarize: V) (1~18GHz)
Uncertainty for Harmonic test	: 4.16% mA
Uncertainty for Flicker test	: 0.43% V
Uncertainty for ESD Test	: 6.00% kV
Uncertainty for EFT/B Test	: 3.84% kV
Uncertainty for Surge Test	: 0.53% kV
Uncertainty for C/S Test	: 1.45dB (Using CDN Test) 2.37dB (Using EM Clamp Test)
Uncertainty for DIPS Test	: 2.12% V
Uncertainty for R/S Test	: 2.10dB(80 MHz-200 MHz) 2.36dB(200 MHz-1000 MHz) 2.57dB(1000 MHz-6000 MHz)

3. MEASURING DEVICE AND TEST EQUIPMENT

3.1. For Power Line Conducted Emission Measurement

Used	Equipment	Manufacturer	Model No.	Serial No.	Last Cal.	Cal. Interval
<input checked="" type="checkbox"/>	Test Receiver	Rohde & Schwarz	ESCI	101108	July 08, 2021	1 Year
<input checked="" type="checkbox"/>	L.I.S.N	Rohde & Schwarz	ENV216	101193	July 08, 2021	1 Year
<input checked="" type="checkbox"/>	L.I.S.N	Schwarzbeck	NSLK 8126	8126-462	July 08, 2021	1 Year
<input checked="" type="checkbox"/>	Pulse Limiter	MTS-systemtechnik	IMP-136	2611115-001-0033	July 08, 2021	1 Year
<input checked="" type="checkbox"/>	RF Switching unit	CD	RSU-M2	38400	July 08, 2021	1 Year

3.2. For Conducted Emissions at Telecommunications/network port Measurement

Item	Equipment	Manufacturer	Model No.	Serial No.	Last Cal.	Cal. Interval
<input checked="" type="checkbox"/>	Test Receiver	Rohde & Schwarz	ESCI	101108	July 08, 2021	1 Year
<input checked="" type="checkbox"/>	I.S.N	Tsetq	ISNT8	51926	Jan. 11, 2021	1 Year
<input checked="" type="checkbox"/>	I.S.N	Tsetq	ISNT8-Cat 6	50583	Jan. 11, 2021	1 Year
<input checked="" type="checkbox"/>	Pulse Limiter	MTS-systemtechnik	IMP-136	2611115-001-0033	July 08, 2021	1 Year
<input checked="" type="checkbox"/>	RF Switching unit	CD	RSU-M2	38400	July 08, 2021	1 Year

3.3. For Radiated Emission Measurement (Up to 1 GHz)

Used	Equipment	Manufacturer	Model No.	Serial No.	Last Cal.	Cal. Interval
<input checked="" type="checkbox"/>	Spectrum Analyzer	Rohde & Schwarz	ESCI	101107	July 08, 2021	1 Year
<input checked="" type="checkbox"/>	EMI Test Receiver	Rohde & Schwarz	ESCI	101107	July 08, 2021	1 Year
<input checked="" type="checkbox"/>	Pre-Amplifier	CD	PAP-0203	22015	July 08, 2021	1 Year
<input checked="" type="checkbox"/>	Bilog Antenna	Schwarzbeck	VULB9163	9163-467	July 12, 2020	2 Year
<input checked="" type="checkbox"/>	Cable	Huber + Suhner	CBL3-NN-0.5 M	101216-21405 00-2	July 08, 2021	1 Year
<input checked="" type="checkbox"/>	Cable	Huber + Suhner	CBL3-NN-3.0 M	101216-21430 00-2	July 08, 2021	1 Year
<input checked="" type="checkbox"/>	Cable	Huber + Suhner	CBL3-NN-9.0 M	101216-21490 00	July 08, 2021	1 Year

3.4. For Radiated Emission Measurement (Above 1 GHz)

Used	Equipment	Manufacturer	Model No.	Serial No.	Last Cal.	Cal. Interval
<input checked="" type="checkbox"/>	Spectrum Analyzer	Agilent	E4407B	MY45107013	April 08, 2021	1 Year
<input checked="" type="checkbox"/>	Pre-Amplifier	Connphy Microwave Inc.	GLN-1G40G-4165-K	0319104	Nov 22, 2021	1 Year
<input checked="" type="checkbox"/>	Horn Antenna	Schwarzbeck	BBHA 9120	9120D-707	April 13, 2021	2 Year
<input checked="" type="checkbox"/>	Cable	SMAMSMAM	A50-0.5M	N/A	July 08, 2021	1 Year
<input checked="" type="checkbox"/>	Cable	SMAMSMAM	A50-3M	N/A	July 08, 2021	1 Year
<input checked="" type="checkbox"/>	Cable	SMAMSMAM	A50-6M	N/A	July 08, 2021	1 Year
<input checked="" type="checkbox"/>	Band Reject Filter	O.M.Jones, Inc. db a	BRM50702-0	G049	July 08, 2021	1 Year
<input type="checkbox"/>	Band Reject Filter	COM-MW Technology co.,Ltd	ZBSF3-C431.4-436.4-751	07204734	July 08, 2021	1 Year

3.5. For Harmonic Current/Flicker Measurement

Used	Equipment	Manufacturer	Model No.	Serial No.	Last Cal.	Cal. Interval
<input checked="" type="checkbox"/>	AC Power source	California Instruments	5001iX-CTS-400-413	59739	July 08, 2021	1 Year
<input checked="" type="checkbox"/>	Harmonic/flicker analyzer	California Instruments	PACS-1	72795	July 08, 2021	1 Year

3.6. For Electrostatic Discharge Immunity Test

Used	Equipment	Manufacturer	Model No.	Serial No.	Last Cal.	Cal. Interval
<input checked="" type="checkbox"/>	ESD Tester	TESEQ	NSG 437	1732	Dec. 01, 2021	1 Year

3.7. For RF Strength Susceptibility Test

Used	Equipment	Manufacturer	Model No.	Serial No.	Last Cal.	Cal. Interval
<input checked="" type="checkbox"/>	Power Amplifier	MILMEGA	AS0102-55	1018770	May 15, 2021	1 Year
<input checked="" type="checkbox"/>	50ohm Diode Power Sensor	BOONTON	51011EMC	34236	May 16, 2021	1 Year
<input checked="" type="checkbox"/>	RF Power Meter. Dual Channel	BOONTON	4232A	10539	May 15, 2021	1 Year
<input checked="" type="checkbox"/>	Log.-Per. Antenna	SCHWARZBECK	VULP 9118E	811	N/A	N/A
<input checked="" type="checkbox"/>	Signal Generator	Agilent	N5181A	MY50145187	May 15, 2021	1 Year
<input checked="" type="checkbox"/>	50ohm Diode Power Sensor	BOONTON	51011EMC	36164	May 15, 2021	1 Year
<input checked="" type="checkbox"/>	Broad-Band Horn Antenna	SCHWARZBECK	STLP 9149	9149-227	N/A	N/A
<input checked="" type="checkbox"/>	Field Strength Meter	DARE	RSS1006A	10I00037SNO 22	May 16, 2021	1 Year
<input checked="" type="checkbox"/>	Multi-function interface system	DARE	CTR1009B	12I00250SNO 72	N/A	N/A
<input checked="" type="checkbox"/>	Automatic switch group	DARE	RSW1004A	N/A	N/A	N/A
<input checked="" type="checkbox"/>	Power Amplifier	MILMEGA	AS1860-50	1059346	May 15, 2021	1 Year
<input checked="" type="checkbox"/>	Power Amplifier	MILMEGA	80RF1000-17 5	1059345	May 17, 2021	1 Year
<input checked="" type="checkbox"/>	Directional Coupler	MILMEGA	DC6180AM1	0340463	May 15, 2021	1 Year
<input checked="" type="checkbox"/>	Audio Analyzer	R&S	UPV	101473	May 15, 2021	1 Year
<input checked="" type="checkbox"/>	Audio Test System	AUDIO PRECISION	ATS-1	41100	May 15, 2021	1 Year

3.8. For Electrical Fast Transient /Burst Immunity Test

Used	Equipment	Manufacturer	Model No.	Serial No.	Last Cal.	Cal. Interval
<input checked="" type="checkbox"/>	Burst Tester	HAEFELY	PEFT4010	173964	July 08, 2021	1 Year
<input checked="" type="checkbox"/>	Coupling Clamp	HAEFELY	IP-4A	147399	July 08, 2021	1 Year

3.9. For Surge Immunity Test

Used	Equipment	Manufacturer	Model No.	Serial No.	Last Cal.	Cal. Interval
<input checked="" type="checkbox"/>	Combination Wave Generator	HTEC	HCWG 100	204303	Dec 21, 2020	1 Year
<input checked="" type="checkbox"/>	Three Phase Coupling/Decoupling Network	HTEC	HCOUPLER 30S	211401	Dec 21, 2020	1 Year
<input checked="" type="checkbox"/>	High Pressure Option	HTEC	Options-10KDC	/	Dec 21, 2020	1 Year
<input checked="" type="checkbox"/>	40 ohm Impedance	HTEC	Options-40ohm	/	Dec 21, 2020	1 Year
<input checked="" type="checkbox"/>	10 ohm Impedance	HTEC	Options-10ohm	/	Dec 21, 2020	1 Year
<input checked="" type="checkbox"/>	Combination Wave Generator	HTEC	HTSG 70	204304	Dec 21, 2020	1 Year
<input checked="" type="checkbox"/>	Coupling Network	HTEC	HCN 8	204901	Dec 21, 2020	1 Year
<input checked="" type="checkbox"/>	Decoupling Network	HTEC	HDEC 8	204902	Dec 21, 2020	1 Year
<input checked="" type="checkbox"/>	Isolated Power Supply	HTEC	SBK-30KVA	/	Dec 21, 2020	1 Year

3.10. For Injected Current Susceptibility Test

Used	Equipment	Manufacturer	Model No.	Serial No.	Last Cal.	Cal. Interval
<input checked="" type="checkbox"/>	Simulator	SCHLODER	CDG-6000-75	126B1404/2016	July 08, 2021	1 Year
<input checked="" type="checkbox"/>	CDN	SCHLODER	CDN-M2+3	A2210415/2016	July 08, 2021	1 Year
<input checked="" type="checkbox"/>	Attenuator	SCHLODER	6dB 100W	HA1615	July 08, 2021	1 Year
<input checked="" type="checkbox"/>	Current Injection Probe	SCHLODER	CDN BCI-P1	19102314-0101	Dec.22, 2020	1 Year
<input checked="" type="checkbox"/>	EM-clamp	SCHLODER	CDN EMCL-20	20102817-0103	Dec.22, 2020	1 Year

3.11. For Voltage Dips and Interruptions Test

Used	Equipment	Manufacturer	Model No.	Serial No.	Last Cal.	Cal. Interval
<input checked="" type="checkbox"/>	Dips Tester	HTEC	HPFS161P	164901	July 08, 2021	1 Year
<input checked="" type="checkbox"/>	AC Power source	HTEC	HV1P16T	164902	July 08, 2021	1 Year

4. CONDUCTED EMISSIONS FROM THE AC MAINS POWER PORTS

4.1. Block Diagram of Test Setup

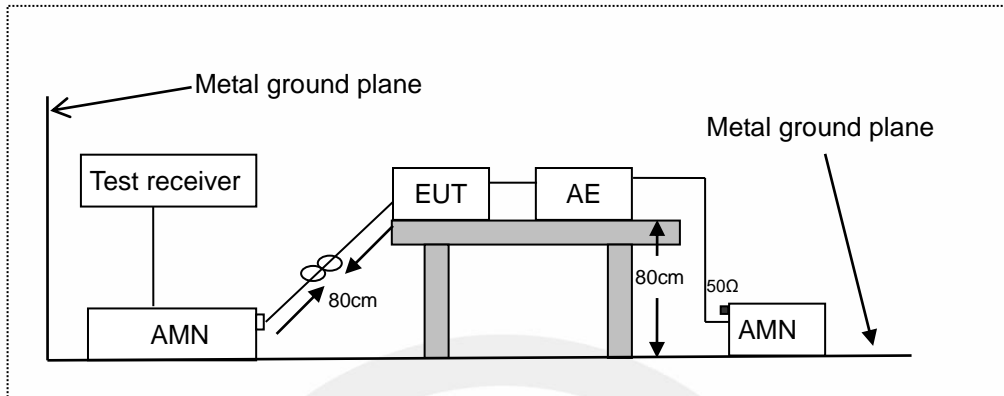

AMN: Artificial Mains Network
 AE: Associated equipment
 EUT: Equipment under test

4.2. Limits

EN 55032, Class B, Table A.10

Frequency range MHz	Coupling device (see Table A.8)	Detector type / bandwidth	Class B limits dB(μV)
0.15 to 0.5	AMN	Quasi Peak / 9 kHz	66 to 56
0.5 to 5			56
5 to 30			60
0.15 to 0.5	AMN	Average / 9 kHz	56 to 46
0.5 to 5			46
5 to 30			50

4.3. Test Procedure

The EUT was placed on a desk 0.8 m height from the metal ground plane and 0.4 m from the conducting wall of the shielding room and it was kept at least 0.8 m from any other grounded conducting surface. The size of the table will nominally be 1.5 m x1.0 m.

The rear of the arrangement shall be flush with the back of the supporting tabletop unless that would not be possible or typical of normal use.

All units of equipment forming the system under test (includes the EUT as well as connected peripherals and associated equipment or devices) shall be arranged such that a nominal 0.1 m separation is achieved between the neighboring units.

Connect EUT to the power mains through a artificial mains network (AMN). Where the mains cable supplied by the manufacturer is longer than 1 m, the excess should be folded at the centre into a bundle no longer than 0.4 m, so that its length is shortened to 1 m.

All the support units are connecting to the other AMN.

The AMN provides 50 ohm coupling impedance for the measuring instrument.

The CISPR states that the AMN with 50 ohm and 50 microhenry should be used.

Both sides of AC line were checked for maximum conducted interference.

The frequency range from 150 kHz to 30 MHz was sweep.

Set the test-receiver system to quasi peak detect function and average detect function, and to measure the conducted emissions values.

Test results were obtained from the following equation:

Measurement (dB μ V) = Correct Factor (dB) + Reading (dB μ V)

Over (dB) = Measurement (dB μ V) - Limit (dB μ V)

4.4. Measuring Results

Pass.

Please refer to the following pages.

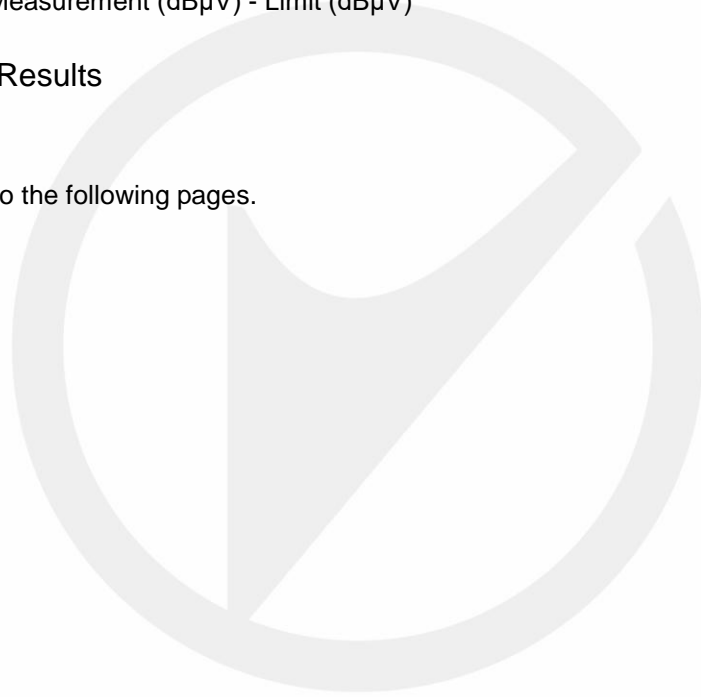

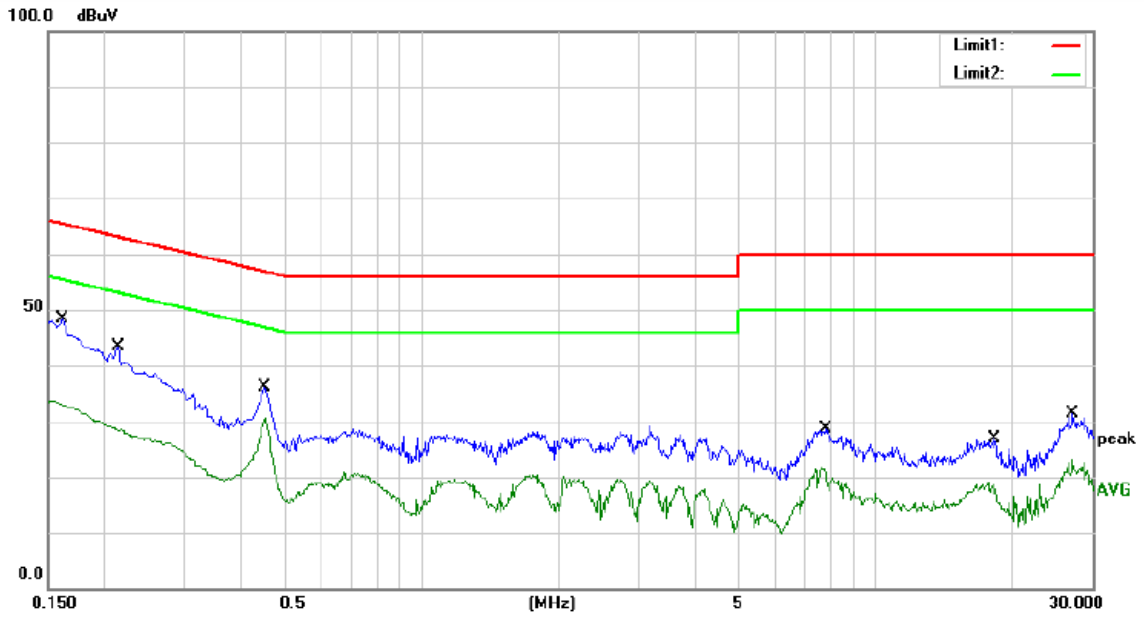

Site site #1 Phase: **L1** Temperature: 24
 Limit: (CE)EN 55032 CLASS B_QP Power: AC 230V/50Hz Humidity: 50 %
 Mode: ON
 Note:

No.	Mk.	Freq. MHz	Reading Level dBuV	Correct Factor dB	Measure- ment dBuV	Limit dBuV	Over dB	Detector	Comment
1		0.1620	38.10	10.10	48.20	65.36	-17.16	QP	
2		0.1620	22.80	10.10	32.90	55.36	-22.46	AVG	
3		0.2140	33.20	10.09	43.29	63.05	-19.76	QP	
4		0.2140	18.20	10.09	28.29	53.05	-24.76	AVG	
5		0.4500	25.90	10.07	35.97	56.88	-20.91	QP	
6	*	0.4500	20.30	10.07	30.37	46.88	-16.51	AVG	
7		7.7280	18.20	10.42	28.62	60.00	-31.38	QP	
8		7.7280	9.10	10.42	19.52	50.00	-30.48	AVG	
9		18.2440	16.20	10.59	26.79	60.00	-33.21	QP	
10		18.2440	7.90	10.59	18.49	50.00	-31.51	AVG	
11		27.1600	20.60	10.76	31.36	60.00	-28.64	QP	
12		27.1600	12.40	10.76	23.16	50.00	-26.84	AVG	

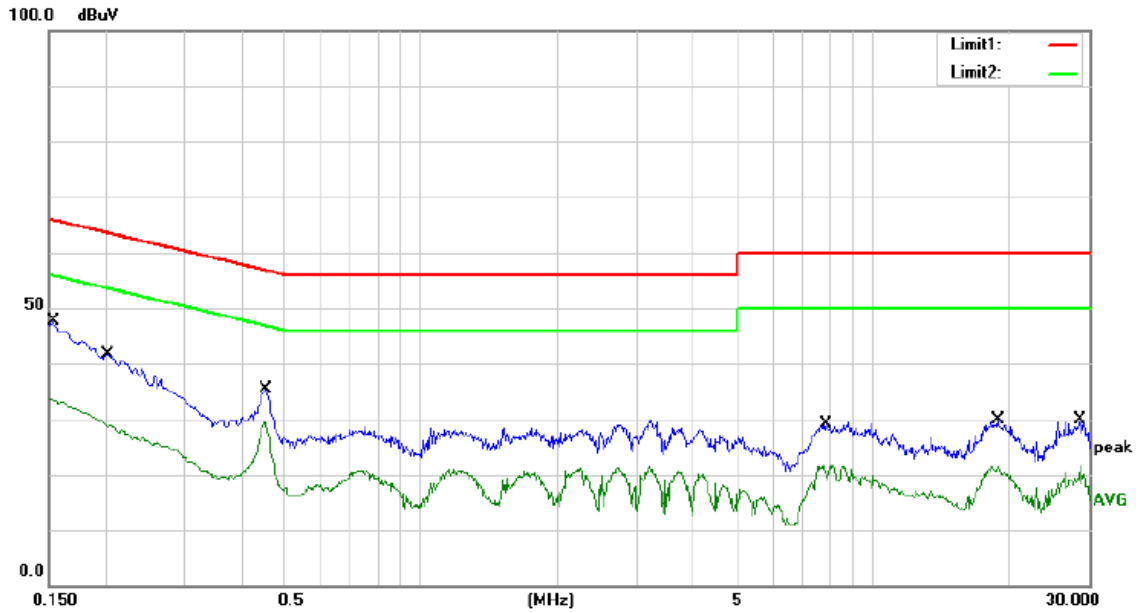

Site site #1 Phase: **N** Temperature: 24
 Limit: (CE)EN 55032 CLASS B_QP Power: AC 230V/50Hz Humidity: 50 %
 Mode: ON
 Note:

No.	Mk.	Freq. MHz	Reading Level dBuV	Correct Factor dB	Measure- ment dBuV	Limit dBuV	Over dB	Detector	Comment
1		0.1540	37.50	10.08	47.58	65.78	-18.20	QP	
2	*	0.1540	31.60	10.08	41.68	55.78	-14.10	AVG	
3		0.2020	31.60	10.08	41.68	63.53	-21.85	QP	
4		0.2020	18.00	10.08	28.08	53.53	-25.45	AVG	
5		0.4540	25.20	10.11	35.31	56.80	-21.49	QP	
6		0.4540	19.20	10.11	29.31	46.80	-17.49	AVG	
7		7.8700	18.60	10.45	29.05	60.00	-30.95	QP	
8		7.8700	9.60	10.45	20.05	50.00	-29.95	AVG	
9		18.9180	19.10	10.65	29.75	60.00	-30.25	QP	
10		18.9180	10.20	10.65	20.85	50.00	-29.15	AVG	
11		28.6860	19.00	10.41	29.41	60.00	-30.59	QP	
12		28.6860	11.10	10.41	21.51	50.00	-28.49	AVG	

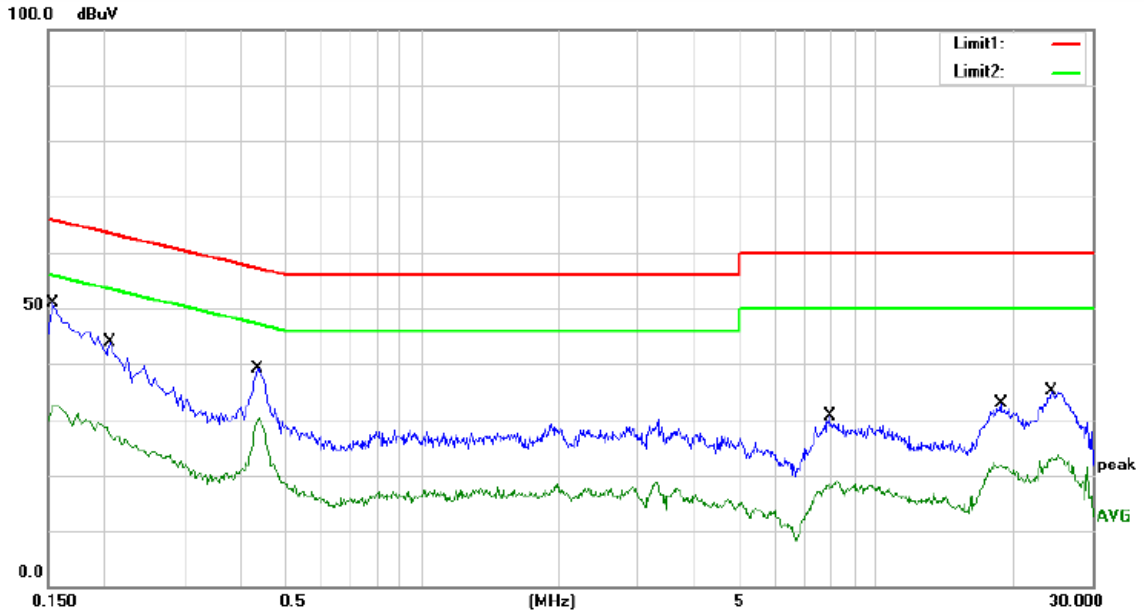

Site site #1 Phase: **N** Temperature: 24
 Limit: (CE)EN 55032 CLASS B_QP Power: AC 120V/60Hz Humidity: 50 %
 Mode: ON
 Note:

No.	Mk.	Freq. MHz	Reading Level dBuV	Correct Factor dB	Measure- ment dBuV	Limit dBuV	Over dB	Detector	Comment
1	*	0.1540	40.80	10.08	50.88	65.78	-14.90	QP	
2		0.1540	22.40	10.08	32.48	55.78	-23.30	AVG	
3		0.2060	33.70	10.08	43.78	63.37	-19.59	QP	
4		0.2060	17.00	10.08	27.08	53.37	-26.29	AVG	
5		0.4340	29.10	10.10	39.20	57.18	-17.98	QP	
6		0.4340	19.90	10.10	30.00	47.18	-17.18	AVG	
7		7.9220	20.10	10.45	30.55	60.00	-29.45	QP	
8		7.9220	7.20	10.45	17.65	50.00	-32.35	AVG	
9		18.9140	22.10	10.65	32.75	60.00	-27.25	QP	
10		18.9140	10.80	10.65	21.45	50.00	-28.55	AVG	
11		24.2900	24.40	10.54	34.94	60.00	-25.06	QP	
12		24.2900	12.70	10.54	23.24	50.00	-26.76	AVG	

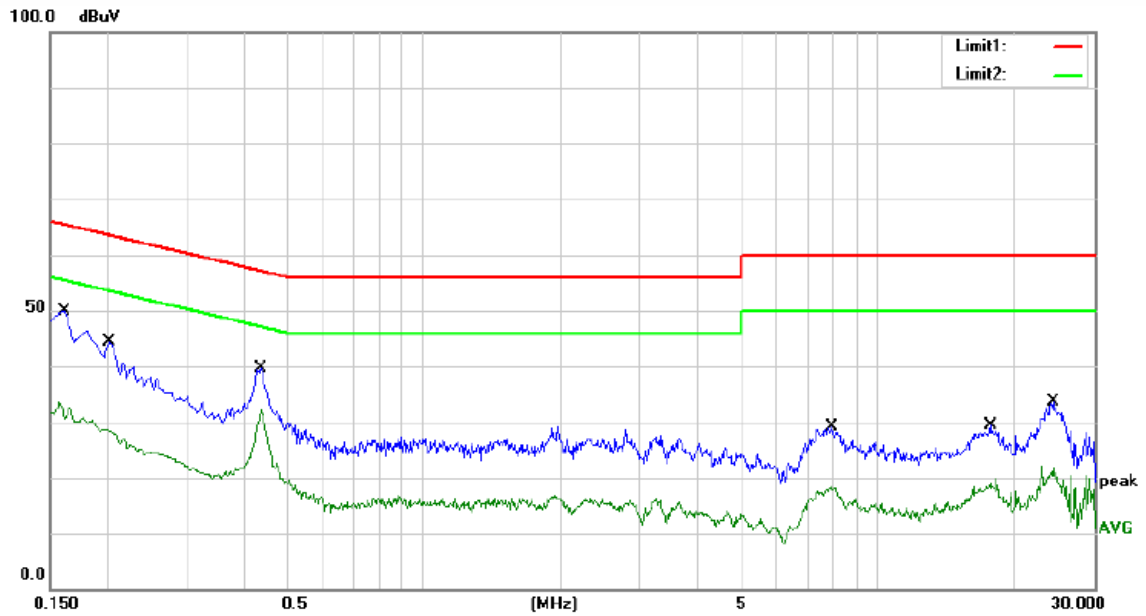

Site site #1 Phase: **L1** Temperature: 24
 Limit: (CE)EN 55032 CLASS B_QP Power: AC 120V/60Hz Humidity: 50 %
 Mode: ON
 Note:

No.	Mk.	Freq. MHz	Reading Level dBuV	Correct Factor dB	Measure- ment dBuV	Limit dBuV	Over dB	Detector	Comment
1		0.1620	39.80	10.10	49.90	65.36	-15.46	QP	
2		0.1620	20.50	10.10	30.60	55.36	-24.76	AVG	
3		0.2020	34.20	10.09	44.29	63.53	-19.24	QP	
4		0.2020	18.30	10.09	28.39	53.53	-25.14	AVG	
5		0.4380	29.60	10.07	39.67	57.10	-17.43	QP	
6	*	0.4380	22.00	10.07	32.07	47.10	-15.03	AVG	
7		7.9580	18.60	10.43	29.03	60.00	-30.97	QP	
8		7.9580	7.30	10.43	17.73	50.00	-32.27	AVG	
9		17.6940	18.60	10.58	29.18	60.00	-30.82	QP	
10		17.6940	7.40	10.58	17.98	50.00	-32.02	AVG	
11		24.3500	22.90	10.70	33.60	60.00	-26.40	QP	
12		24.3500	10.40	10.70	21.10	50.00	-28.90	AVG	

5. ASYMMETRIC MODE CONDUCTED EMISSIONS AT WIRED NETWORK PORTS

5.1. Block Diagram of Test Setup

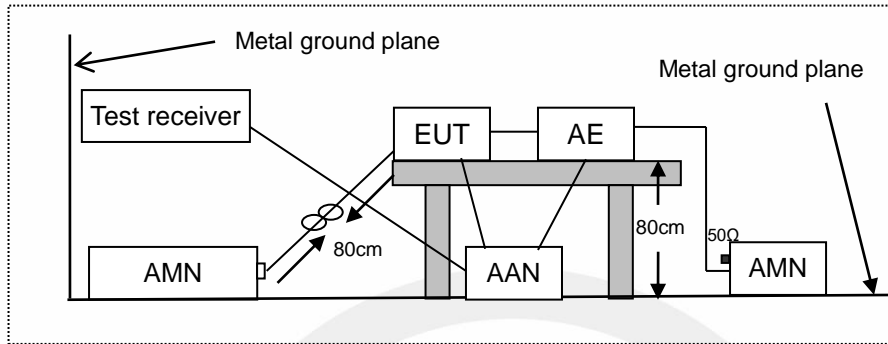

AMN: Artificial mains network
 AE: Associated equipment
 EUT: Equipment under test
 AAN: Asymmetric artificial network

5.2. Limits

EN 55032, Class B, Table A.12

Frequency range (MHz)	Coupling device (see Table A.8)	Detector type / bandwidth	Class B voltage limits dB(μ V)	Class B current limits dB(μ A)
0.15 to 0.5	AAN	Quasi Peak / 9 kHz	84 to 74	N/A
0.5 to 30			74	
0.15 to 0.5	AAN	Average / 9 kHz	74 to 64	
0.5 to 30			64	
0.15 to 0.5	CVP and current probe	Quasi Peak / 9 kHz	84 to 74	40 to 30
0.5 to 30			74	30
0.15 to 0.5	CVP and current probe	Average / 9 kHz	74 to 64	30 to 20
0.5 to 30			64	20
0.15 to 0.5	Current Probe	Quasi Peak / 9 kHz	N/A	40 to 30
0.5 to 30				30
0.15 to 0.5	Current Probe	Average / 9 kHz		30 to 20
0.5 to 30				20

5.3. Test Procedure

The EUT is put on the plane 0.8m high above the ground by insulating support and connected to the AC mains through artificial mains network(AMN) or connected to the wired network port through an asymmetric artificial network(AAN). AMN provided a 50ohm coupling impedance for the tested equipment AC mains port, AAN provided a common mode (asymmetric mode) impedance of 150 Ω to the wired network port under test. Both sides of AC line and the wired network line are investigated to

find out the maximum conducted emission according to the EN 55032 regulations during conducted emission measurement.

The bandwidth of the receiver is set at 9 kHz in 150 kHz~30 MHz. The frequency range from 150 kHz to 30 MHz is investigated.

Test results were obtained from the following equation:

Measurement (dB μ V) = Correct Factor (dB) + Reading (dB μ V)

Over (dB) = Measurement (dB μ V) - Limit (dB μ V)

5.4. Measuring Results

Pass.

Please refer to the following pages.



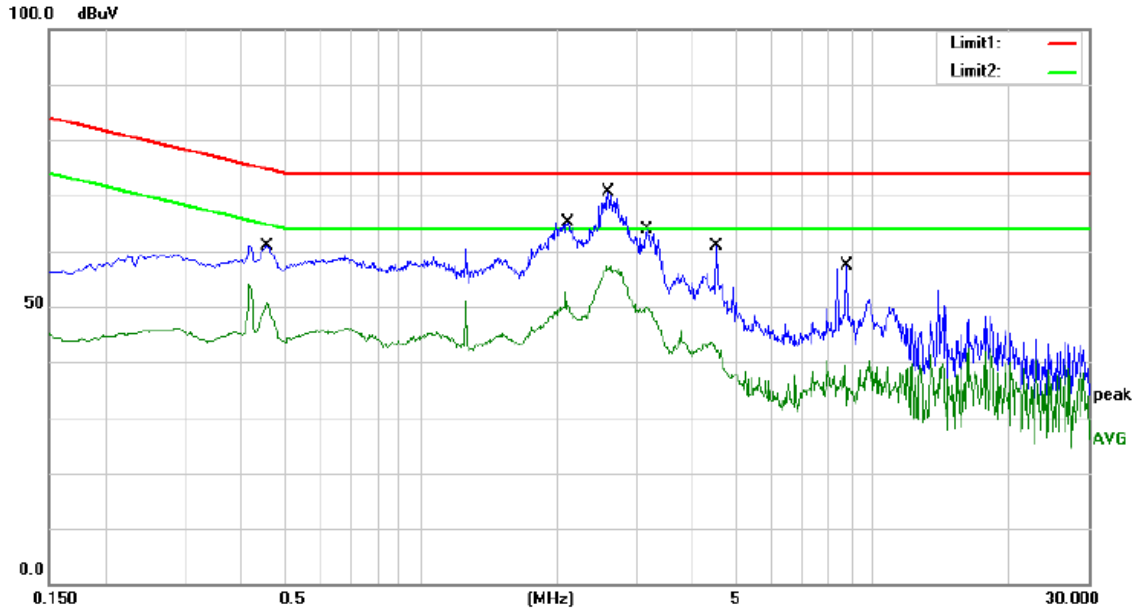

Site site #1 Phase: Temperature: 24
 Limit: (CE)EN 55032 Class B TELECOM_QP Power: AC 230V/50Hz Humidity: 50 %
 Mode: ON
 Note:

No.	Mk.	Freq. MHz	Reading Level dBuV	Correct Factor dB	Measure- ment dBuV	Limit dBuV	Over dB	Detector	Comment
1		0.4580	35.90	19.84	55.74	74.73	-18.99	QP	
2		0.4580	30.30	19.84	50.14	64.73	-14.59	AVG	
3		2.1140	39.80	19.67	59.47	74.00	-14.53	QP	
4		2.1140	30.10	19.67	49.77	64.00	-14.23	AVG	
5		2.5980	45.20	19.71	64.91	74.00	-9.09	QP	
6	*	2.5980	36.90	19.71	56.61	64.00	-7.39	AVG	
7		3.1620	37.40	19.75	57.15	74.00	-16.85	QP	
8		3.1620	29.80	19.75	49.55	64.00	-14.45	AVG	
9		4.5140	28.40	19.85	48.25	74.00	-25.75	QP	
10		4.5140	21.90	19.85	41.75	64.00	-22.25	AVG	
11		8.7460	24.50	19.90	44.40	74.00	-29.60	QP	
12		8.7460	19.40	19.90	39.30	64.00	-24.70	AVG	

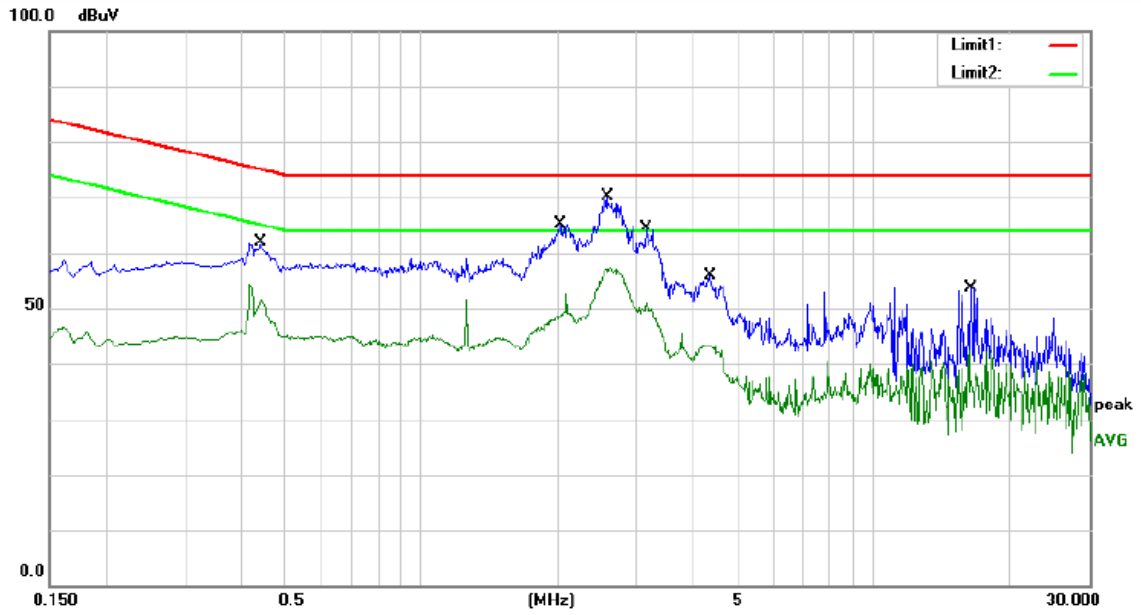

Site site #1 Phase: Temperature: 24
 Limit: (CE)EN 55032 Class B TELECOM_QP Power: AC 120V/60Hz Humidity: 50 %
 Mode: ON
 Note:

No.	Mk.	Freq. MHz	Reading Level dBuV	Correct Factor dB	Measure- ment dBuV	Limit dBuV	Over dB	Detector	Comment
1		0.4420	36.50	19.84	56.34	75.02	-18.68	QP	
2		0.4420	31.70	19.84	51.54	65.02	-13.48	AVG	
3		2.0260	38.40	19.66	58.06	74.00	-15.94	QP	
4		2.0260	28.80	19.66	48.46	64.00	-15.54	AVG	
5		2.5780	45.50	19.70	65.20	74.00	-8.80	QP	
6	*	2.5780	36.90	19.70	56.60	64.00	-7.40	AVG	
7		3.1500	37.60	19.75	57.35	74.00	-16.65	QP	
8		3.1500	30.20	19.75	49.95	64.00	-14.05	AVG	
9		4.3460	29.70	19.84	49.54	74.00	-24.46	QP	
10		4.3460	23.10	19.84	42.94	64.00	-21.06	AVG	
11		16.4740	21.40	19.91	41.31	74.00	-32.69	QP	
12		16.4740	17.30	19.91	37.21	64.00	-26.79	AVG	

6. RADIATED EMISSION MEASUREMENT (UP TO 1GHz)

6.1. Block Diagram of Test Setup

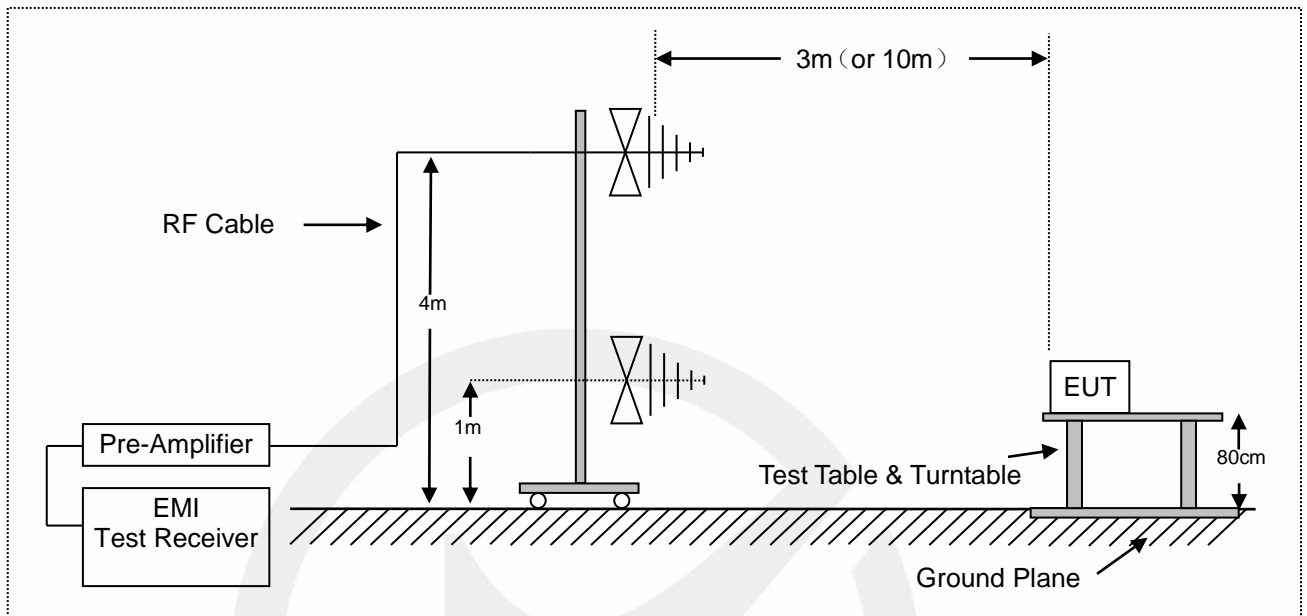

6.2. Radiated Limit

EN 55032, Class B, Table A.4

Frequency range MHz	Measurement			Class B limits dB(μV/m)
	Facility	Distance (m)	Detector type / bandwidth	
30 to 230	OATS/SAC	10	Quasi Peak / 120 kHz	30
230 to 1 000				37
30 to 230	OATS/SAC	3		40
230 to 1 000				47

6.3. Test Procedure

The EUT was placed on a non-conductive table whose total height equaled 80cm. All units of equipment forming the system under test (includes the EUT as well as connected peripherals and associated equipment or devices) shall be arranged such that a nominal 0.1 m separation is achieved between the neighboring units. Where the mains cable supplied by the manufacturer is longer than 1 m, the excess should be folded at the centre into a bundle no longer than 0.4 m, so that its length is shortened to 1 m.

The EUT was set 3 meters (or 10 meters) away from the receiving antenna that was mounted on a non-conductive mast. The antenna can move up and down between 1 to 4 meters to find out the maximum emission level.

The turntable can rotate 360 degree to determine the position of the maximum emission level.

The initial testing identified the frequency that has the highest disturbance relative to the limit while operating the EUT in typical modes of operation and cable positions in a test setup representative of typical system configuration.

The identification of the frequency of highest emission with respect to the limit was found by investigating emissions at a number of significant frequencies. The probable frequency of maximum emission had been found and that the associated cable and EUT configuration and mode of operation had been identified.

The bandwidth of the Receiver is set at 120 kHz.

Test results were obtained from the following equation:

Measurement (dB μ V) = Correct Factor (dB) + Reading (dB μ V)

Over (dB) = Measurement (dB μ V) - Limit (dB μ V)

6.4. Measuring Results

Pass.

Please refer to the following pages.

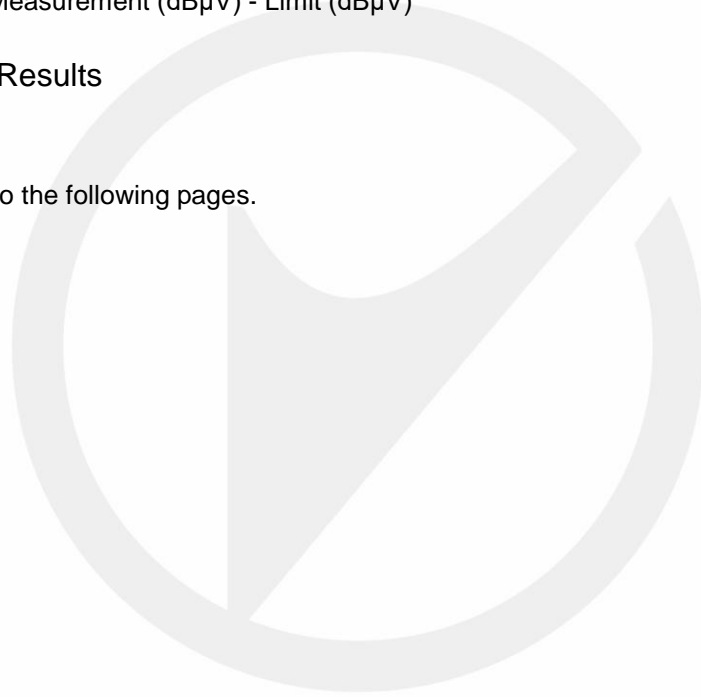

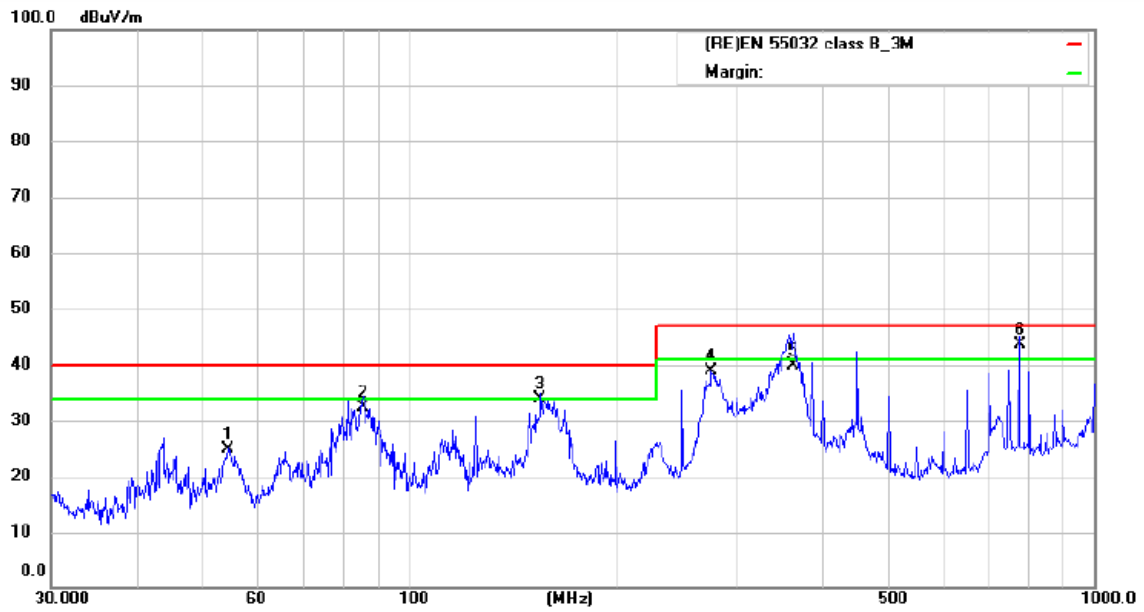

Site Radiated Emission 3m #1 Polarization: **Horizontal** Temperature: 24
 Limit: (RE)EN 55032 class B_3M Power: AC 230V/50Hz Humidity: 55 %
 Mode: ON
 Note:

No.	Mk.	Freq. MHz	Reading Level dBuV	Correct Factor dB	Measure- ment dBuV/m	Limit dBuV/m	Over dB	Antenna Height cm	Table Degree	Comment
1		54.4515	46.12	-21.12	25.00	40.00	-15.00			QP
2		85.5974	58.90	-26.60	32.30	40.00	-7.70			QP
3		155.3642	60.81	-27.01	33.80	40.00	-6.20			QP
4		276.1234	59.41	-20.61	38.80	47.00	-8.20			QP
5		362.9844	59.24	-19.24	40.00	47.00	-7.00			QP
6	*	776.8778	53.26	-9.66	43.60	47.00	-3.40			QP

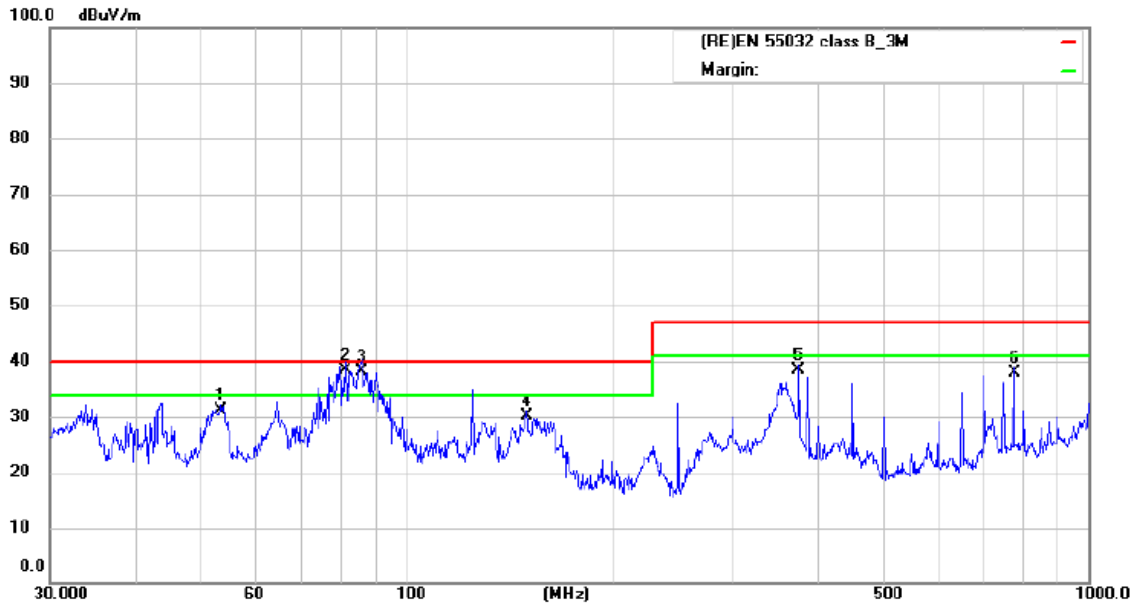

Site Radiated Emission 3m #1
 Limit: (RE)EN 55032 class B_3M
 Mode: ON
 Note:

Polarization: *Vertical*
 Power: AC 230V/50Hz

Temperature: 24
 Humidity: 55 %

No.	Mk.	Freq. MHz	Reading Level dBuV	Correct Factor dB	Measure- ment dBuV/m	Limit dBuV/m	Over dB	Detector	Antenna Height cm	Table Degree degree	Comment
1		53.5052	52.21	-21.01	31.20	40.00	-8.80	QP			
2	*	81.2116	65.88	-27.48	38.40	40.00	-1.60	QP			
3	!	85.8984	64.67	-26.47	38.20	40.00	-1.80	QP			
4		150.0107	56.33	-26.23	30.10	40.00	-9.90	QP			
5		375.9384	56.71	-18.41	38.30	47.00	-8.70	QP			
6		776.8777	47.66	-9.66	38.00	47.00	-9.00	QP			

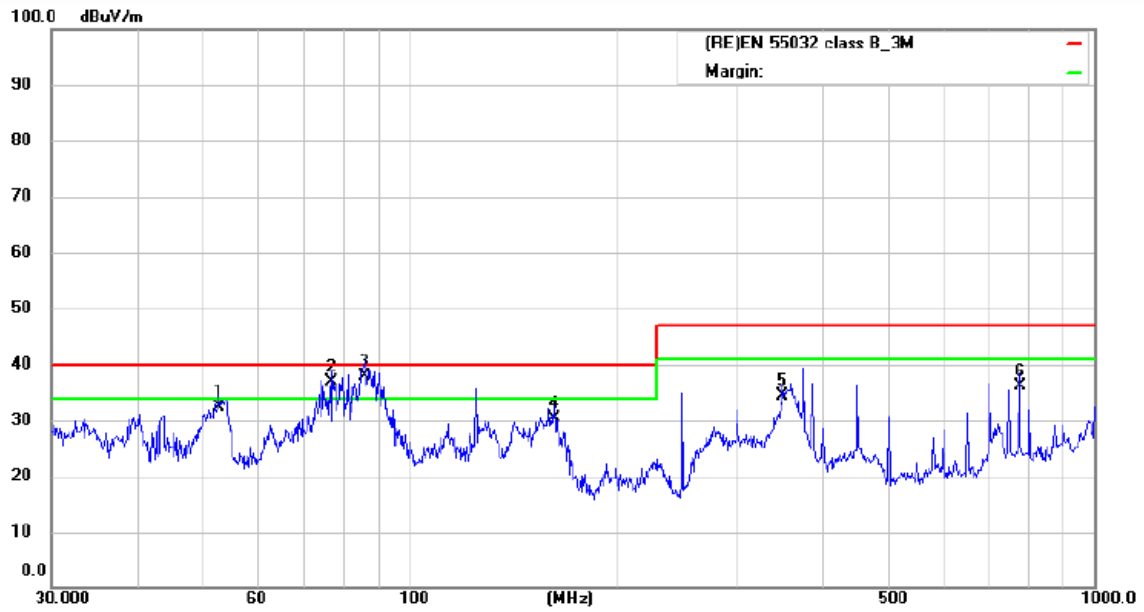

Site Radiated Emission 3m #1

Polarization: *Vertical*

Temperature: 24

Limit: (RE)EN 55032 class B_3M

Power: AC 120V/60Hz

Humidity: 55 %

Mode: ON

Note:

No.	Mk.	Freq. MHz	Reading Level dBuV	Correct Factor dB	Measure- ment dBuV/m	Limit dBuV/m	Over dB	Detector	Antenna Height cm	Table Degree degree	Comment
1		52.5752	53.52	-21.02	32.50	40.00	-7.50	QP			
2	!	77.0503	64.20	-27.40	36.80	40.00	-3.20	QP			
3	*	85.8984	64.37	-26.47	37.90	40.00	-2.10	QP			
4		162.6105	57.28	-26.98	30.30	40.00	-9.70	QP			
5		350.4766	54.07	-19.57	34.50	47.00	-12.50	QP			
6		776.8777	45.86	-9.66	36.20	47.00	-10.80	QP			

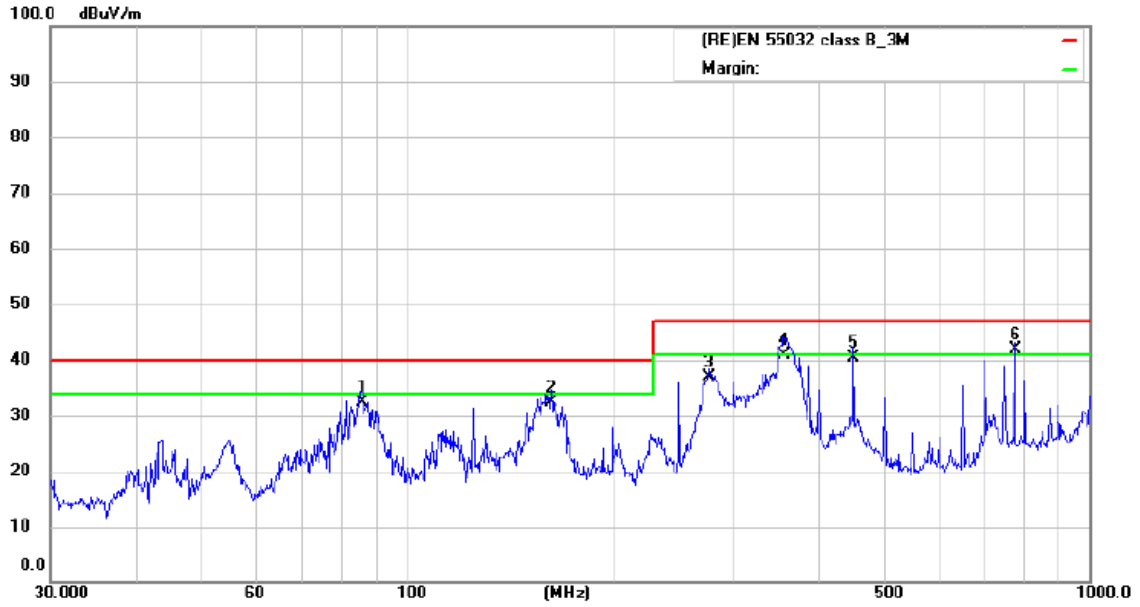

Site Radiated Emission 3m #1
 Limit: (RE)EN 55032 class B_3M
 Mode: ON
 Note:

Polarization: **Horizontal**
 Power: AC 120V/60Hz

Temperature: 24
 Humidity: 55 %

No.	Mk.	Freq. MHz	Reading Level dBuV	Correct Factor dB	Measure- ment dBuV/m	Limit dBuV/m	Over dB	Detector	Antenna Height cm	Table Degree degree	Comment
1		85.8983	58.97	-26.47	32.50	40.00	-7.50	QP			
2		162.6105	59.38	-26.98	32.40	40.00	-7.60	QP			
3		277.0935	57.43	-20.63	36.80	47.00	-10.20	QP			
4		355.4273	60.50	-19.50	41.00	47.00	-6.00	QP			
5		451.1349	58.63	-18.33	40.30	47.00	-6.70	QP			
6	*	776.8778	51.56	-9.66	41.90	47.00	-5.10	QP			

7. RADIATED EMISSION MEASUREMENT (ABOVE 1GHz)

7.1. Block Diagram of Test Setup

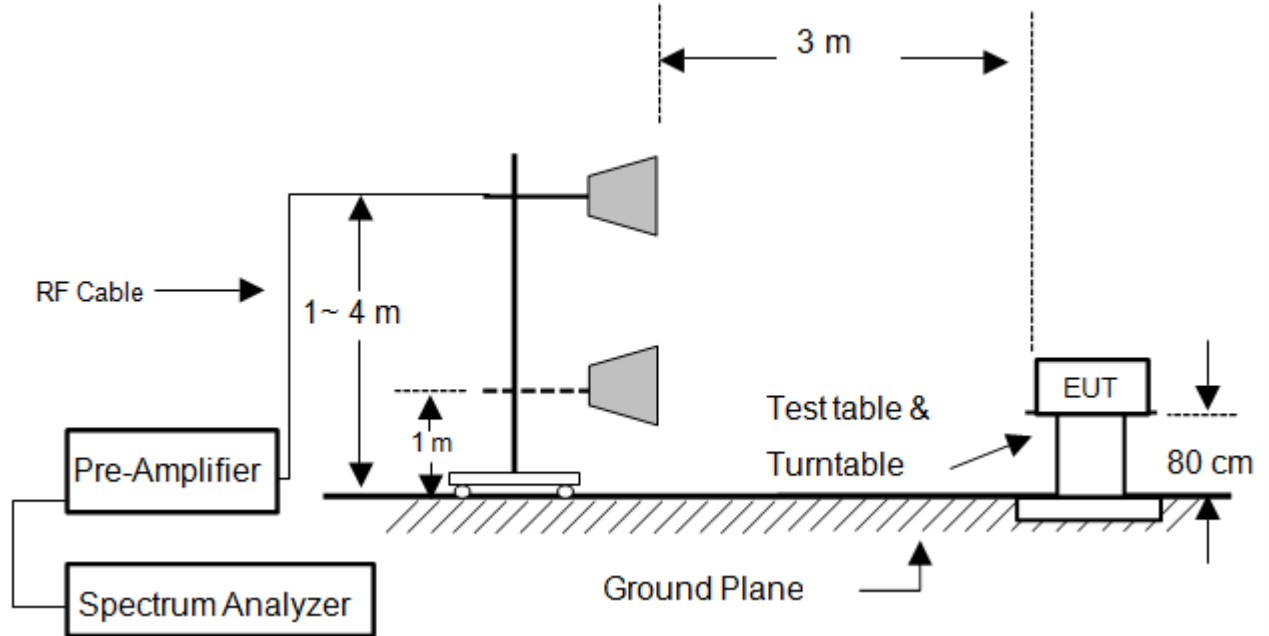

7.2. Radiated Limit

EN 55032, Class B, Table A.5

Frequency range (MHz)	Measurement			Class B limits dB(μ V/m)
	Facility	Distance (m)	Detector type/ bandwidth	
1000 to 3000	FSOATS	3	Average / 1 MHz	50
3000 to 6000				54
1000 to 3000			Peak / 1 MHz	70
3000 to 6000				74

Note: The highest internal source of an EUT is defined as the highest frequency generated or used within the EUT or on which the EUT operates or tunes. If the highest frequency of the internal sources of the EUT is less than 108 MHz, the measurement shall only be made up to 1 GHz. If the highest frequency of the internal sources of the EUT is between 108 MHz and 500 MHz the measurement shall only be made up to 2 GHz. If the highest frequency of the internal sources of the EUT is between 500 MHz and 1 GHz, the measurement shall only be made up to 5 GHz. If the highest frequency of the internal sources of the EUT is above 1 GHz, the measurement shall be made up to 5 times the highest frequency or 6 GHz, whichever is less.

7.3. Test Procedure

The EUT was placed on a non-conductive table whose total height equaled 80cm. All units of equipment forming the system under test (includes the EUT as well as connected peripherals and associated equipment or devices) shall be arranged such that a nominal 0.1 m separation is achieved between the neighboring units. Where the mains cable supplied by the manufacturer is longer than 1 m, the excess should be folded at the centre into a bundle no longer than 0.4 m, so that its length is shortened to 1 m.

The EUT was set 3 meters away from the receiving antenna that was mounted on a non-conductive mast. The antenna can move up and down between 1 to 4 meters to find out the maximum emission level.

The turntable can rotate 360 degree to determine the position of the maximum emission level.

The initial testing identified the frequency that has the highest disturbance relative to the limit while operating the EUT in typical modes of operation and cable positions in a test setup representative of typical system configuration.

The identification of the frequency of highest emission with respect to the limit was found by investigating emissions at a number of significant frequencies. The probable frequency of maximum emission had been found and that the associated cable and EUT configuration and mode of operation had been identified.

The frequency range above 1GHz the measuring instrument use RBW=1 MHz and VBW=3 MHz.

Test results were obtained from the following equation:

Measurement (dB μ V) = Correct Factor (dB) + Reading (dB μ V)

Over (dB) = Measurement (dB μ V) - Limit (dB μ V)

7.4. Measuring Results

Pass.

Please refer to the following pages.

■ Radiated Emission Above 1GHz

Test mode: ON Humidity: 55%
 Temperature: 24°C Test Voltage: AC 230V/50Hz
 Test Date: 2021-11-29

Freq. (MHz)	Ant.Pol. H/V	Emission Level(dBuV/m)		Limit 3m(dBuV/m)		Over(dB)	
		PK	AV	PK	AV	PK	AV
4049.020	V	44.10	36.20	74.00	54.00	-29.90	-17.80
4264.706	V	45.10	35.90	74.00	54.00	-28.90	-18.10
4975.490	V	47.80	39.60	74.00	54.00	-26.20	-14.40
5137.255	V	47.40	38.70	74.00	54.00	-26.60	-15.30
5583.333	V	48.30	39.60	74.00	54.00	-25.70	-14.40
5833.333	V	47.60	38.70	74.00	54.00	-26.40	-15.30
3426.470	H	44.30	35.20	70.00	50.00	-29.70	-18.80
4044.118	H	46.70	37.80	70.00	50.00	-27.30	-16.20
4818.627	H	47.40	38.60	70.00	50.00	-26.60	-15.40
5303.922	H	49.80	40.10	70.00	50.00	-24.20	-13.90
5421.569	H	50.40	41.30	70.00	50.00	-23.60	-12.70
5622.549	H	49.20	40.10	74.00	54.00	-24.80	-13.90

Test mode: ON Humidity: 55%
 Temperature: 24°C Test Voltage: AC 120V/60Hz
 Test Date: 2021-11-29

Freq. (MHz)	Ant.Pol. H/V	Emission Level(dBuV/m)		Limit 3m(dBuV/m)		Over(dB)	
		PK	AV	PK	AV	PK	AV
2313.725	V	39.10	35.10	70.00	50.00	-30.90	-14.90
2936.274	V	39.90	34.20	70.00	50.00	-30.10	-15.80
3598.039	V	40.00	33.50	74.00	54.00	-34.00	-20.50
4049.020	V	41.60	36.20	74.00	54.00	-32.40	-17.80
4774.510	V	41.60	34.30	74.00	54.00	-32.40	-19.70
5500.000	V	46.70	38.10	74.00	54.00	-27.30	-15.90
2759.804	H	42.90	37.60	70.00	50.00	-27.10	-12.40
3367.647	H	43.00	38.60	74.00	54.00	-31.00	-15.40
3857.843	H	43.70	37.60	74.00	54.00	-30.30	-16.40
4534.314	H	44.50	38.10	74.00	54.00	-29.50	-15.90
4897.059	H	45.90	39.10	74.00	54.00	-28.10	-14.90
5372.549	H	46.90	39.70	74.00	54.00	-27.10	-14.30

8. HARMONIC CURRENT EMISSION MEASUREMENT

8.1. Block Diagram of Test Setup

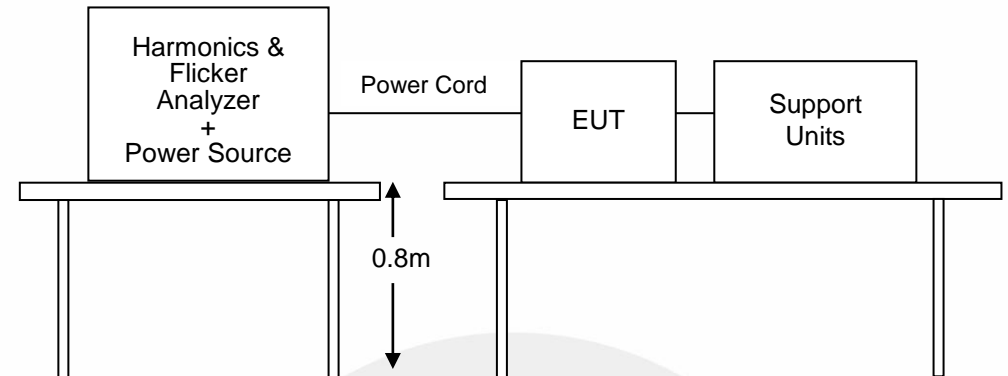

8.2. Standard Limits

EN IEC 61000-3-2, CLASS A

Harmonic current emissions evaluate the potential for the EUT to cause distortion on the AC power lines. It is applicable to electrical and electronic equipment having an input current ≤ 16 A per phase, and intended to be connected to public low-voltage distribution systems

Table 1 - Limits for Class A equipment

Harmonic order n	Maximum permissible harmonic current (A)
Odd harmonics	
3	2.30
5	1.14
7	0.77
9	0.40
11	0.33
13	0.21
$15 \leq n \leq 39$	$0.15 \frac{0.15}{n}$
Even harmonics	
2	1.08
4	0.43
6	0.30
$8 \leq n \leq 40$	$0.23 \frac{8}{n}$

8.3. Test Procedure

The measurement of harmonic currents shall be performed as follows: i. For each harmonic order, measure the 1.5 s smoothed r.m.s. harmonic current in each DFT time window as defined in EN / IEC 61000-4-7:2009. ii. Calculate the arithmetic average of the measured values from the DFT time windows, over the entire observation period Short cyclic ($T \text{ cycle} \leq 2.5 \text{ min}$). Because of synchronisation to meet the requirements for repeatability in 5%.

8.4. Test Results

Pass.

Please refer to the following pages.



Harmonics – Class-A per IEC 61000-3-2 (Run time)

EUT: DataHub(DataHub1000)	Tested by: LSL
Test category: Class-A (European limits)	Test Margin: 100
Test date: 2021/12/1	Start time: 10:36:19
Test duration (min): 2.5	End time: 10:39:00
Comment: ON	Data file name: H-000222.cts_data
Customer: Customer	

Test Result: Pass Source qualification: Normal

Current & voltage waveforms

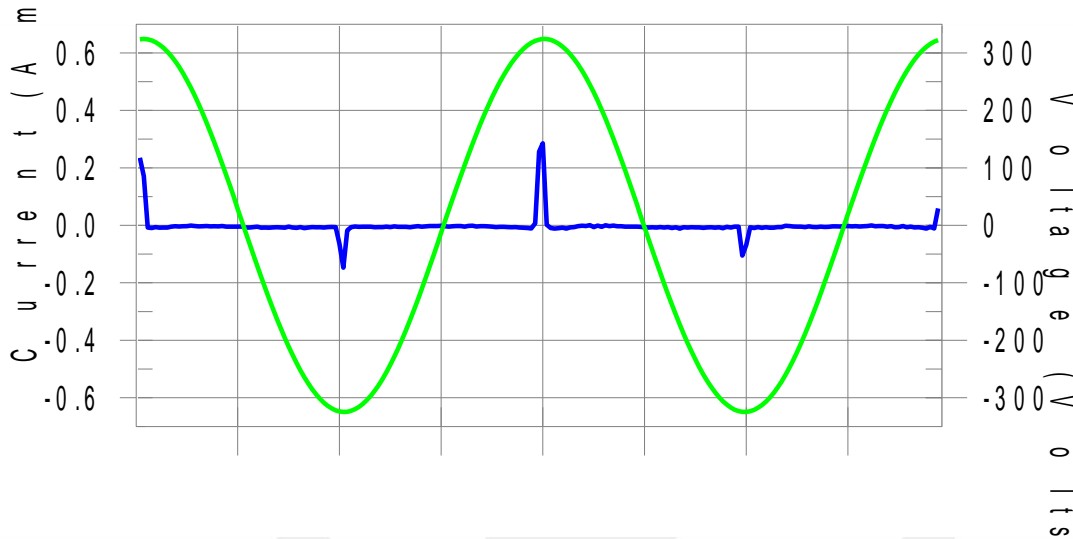

Harmonics and Class A limit line European Limits

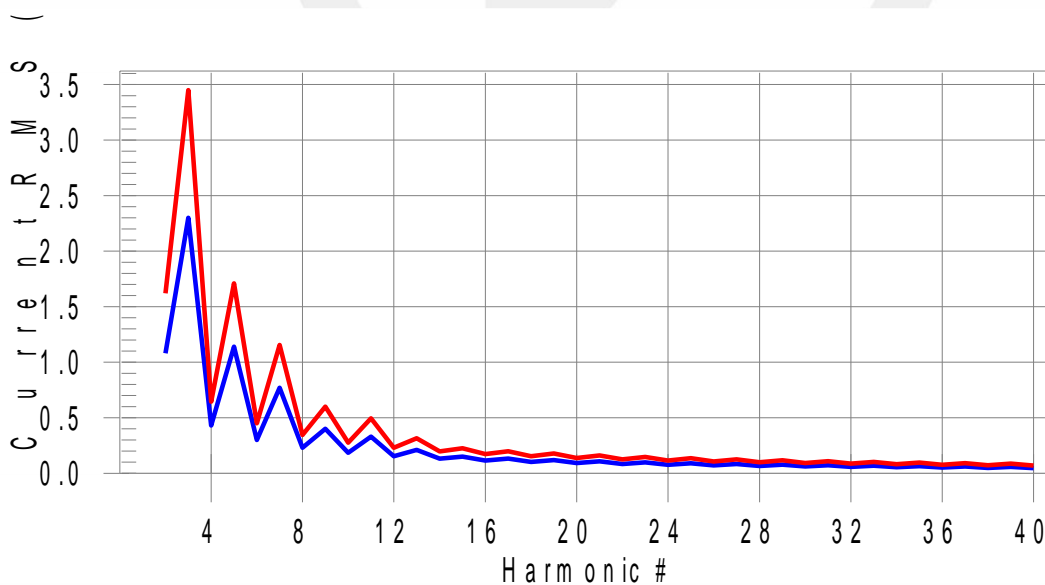

Test result: Pass Worst harmonics H23-3.8% of 150% limit, H23-5.5% of 100% limit

9. VOLTAGE FLUCTUATION AND FLICKER MEASUREMENT

9.1. Block Diagram of Test Setup

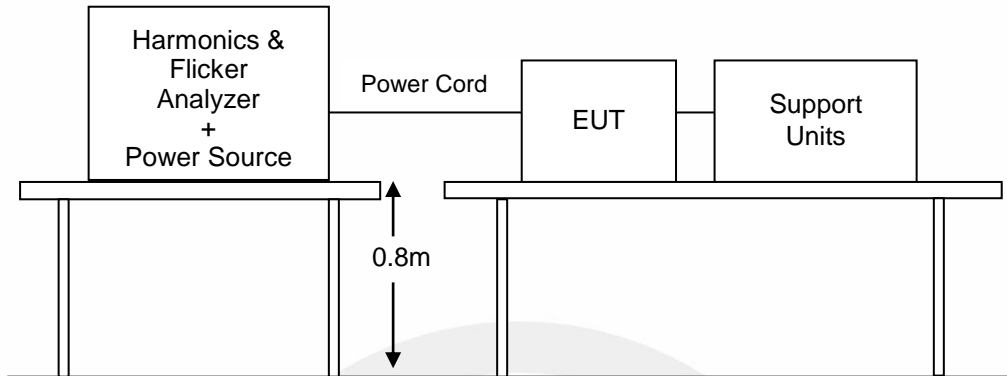

9.2. Standard Limits

EN 61000-3-3 Limits

The objective of voltage changes, voltage fluctuations and flicker in public low voltage supply systems during equipment with rated current ≤ 16 A per phase, ensures that home appliances and certain other electrical equipment do not adversely affect lighting equipment when connected to the same power system.

Voltage Fluctuation and Flicker Limits:

- the value of P_{st} shall not be greater than 1.0;
- the value of Plt shall not be greater than 0.65;
- the value of $d(t)$ during a voltage change shall not exceed 3.3 % for more than 500 ms;
- the relative steady-state voltage change, dc , shall not exceed 3.3 %;
- the maximum relative voltage change, d_{max} , shall not exceed 4.0 %;

9.3. Test Procedure

The total impedance of the test circuit, excluding the appliance under test, but including the internal impedance of the supply source, shall be equal to the reference impedance. The stability and tolerance of the reference impedance shall be adequate to ensure that the overall accuracy of 8% is achieved during the whole assessment procedure.

9.4. Test Results

Pass.

Please refer to the following pages.

10. IMMUNITY GENERAL PERFORMANCE CRITERIA DESCRIPTION

General performance criteria are defined in EN 55035 clause 8.2, 8.3 and 8.4. These criteria shall be used during the testing of primary functions where no relevant annex is applicable.

When assessing the impact of a disturbance on a function, the assessment should take into consideration the function's performance prior to the application of the disturbance and only identify as failures those changes in performance that are a result of the disturbance.

EN 55035:

Performance criterion A

The equipment shall continue to operate as intended without operator intervention. No degradation of performance, loss of function or change of operating state is allowed below a performance level specified by the manufacturer when the equipment is used as intended. The performance level may be replaced by a permissible loss of performance. If the minimum performance level or the permissible performance loss is not specified by the manufacturer, then either of these may be derived from the product description and documentation, and by what the user may reasonably expect from the equipment if used as intended.

Performance criterion B

During the application of the disturbance, degradation of performance is allowed. However, no unintended change of actual operating state or stored data is allowed to persist after the test.

After the test, the equipment shall continue to operate as intended without operator intervention; no degradation of performance or loss of function is allowed, below a performance level specified by the manufacturer, when the equipment is used as intended. The performance level may be replaced by a permissible loss of performance.

If the minimum performance level (or the permissible performance loss), or recovery time, is not specified by the manufacturer, then either of these may be derived from the product description and documentation, and by what the user may reasonably expect from the equipment if used as intended.

Performance criterion C

Loss of function is allowed, provided the function is self-recoverable, or can be restored by the operation of the controls by the user in accordance with the manufacturer's instructions. A reboot or re-start operation is allowed. Information stored in non-volatile memory, or protected by a battery backup, shall not be lost.

11. ELECTROSTATIC DISCHARGE

11.1. Test Specification

Test standard	: EN 55035
Basic standard	: IEC 61000-4-2
Performance criterion	: B
Test level	: ±8.0kV (Air discharge) ±4.0kV (Contact discharge)

11.2. Block Diagram of Test Setup

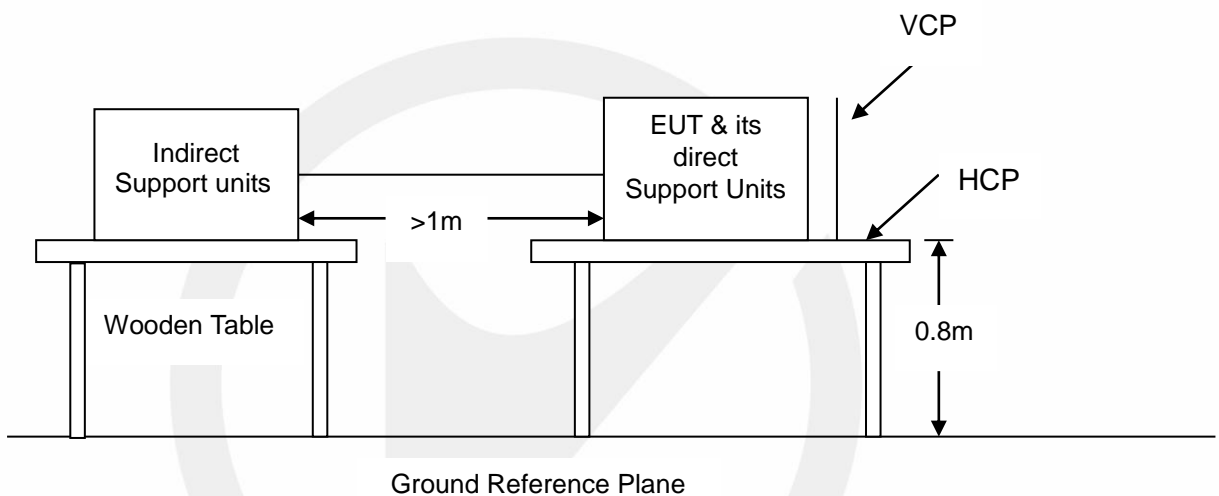

11.3. Test Procedure

- In the case of air discharge testing, the climatic conditions shall be within the following ranges:
 - ambient temperature: 15°C to 35°C;
 - relative humidity : 30% to 60%;
 - atmospheric pressure : 86 kPa (860 mbar) to 106 kPa (1060 mbar)
- Test programs and software shall be chosen so as to exercise all normal modes of operation of the EUT. The use of special exercising software is encouraged, but permitted only where it can be shown that the EUT is being comprehensively exercised.
- In the case of contact discharges, the tip of the discharge electrode shall touch the EUT before the discharge switch is operated.
- In the case of painted surface covering a conducting substrate, the following procedure shall be adopted :
 - If the coating is not declared to be an insulating coating by the equipment manufacturer, then the pointed tip of the generator shall penetrate the coating so as to make contact with the conducting substrate.
 - Coating declared as insulating by the manufacturer shall only be submitted to the air discharge.
 - The contact discharge test shall not be applied to such surfaces.
- In the case of air discharges, the round discharge tip of the discharge electrode shall be approached as fast as possible (without causing mechanical damage) to touch the EUT. After each discharge, the ESD generator (discharge electrode) shall be removed from the EUT. The generator is then retriggered for a new single discharge. This procedure shall be repeated until the discharges are completed. In the case of an air discharge test, the discharge switch, which is used for contact discharge, shall be closed.

- f. The test voltage shall be increased from the minimum to the selected test severity level, in order to determine any threshold of failure. The final test level should not exceed the product specification value in order to avoid damage to the equipment.
- g. The test shall be performed with both air discharge and contact discharge. The test shall be performed with single discharges. On each pre-selected point at least 10 single discharges (in the most sensitive polarity) shall be applied. For the time interval between successive single discharges an initial value of 1 s is recommended. Longer intervals may be necessary to determine whether a system failure has occurred.
- h. Ensure that the applied charge on the EUT has been dis-charged before next ESD pulse.

11.4. Test Results

Pass.

Temperature : 22 °C
 Humidity : 47 %
 Atmospheric Pressure : 101kpa
 Test Engineer : LSL
 Test Date : 2021-12-01

Air Discharge:

Test Voltage	Location	Actual criterion	Required performance criterion	Result (Pass/Fail)
±2; 4; 8 kV	Non-Conducted Enclosure	A	B	Pass
±2; 4; 8 kV	/	/	B	/
±2; 4; 8 kV	/	/	B	/

Contact Discharge

Test Voltage	Location	Actual criterion	Required performance criterion	Result (Pass/Fail)
±2; 4kV	Conducted Enclosure	A	B	Pass
±2; 4kV	Screw	A	B	Pass
±2; 4kV	All slots of the EUT	A	B	Pass

Indirect Discharge

Test Voltage	Location	Actual criterion	Required performance criterion	Result (Pass/Fail)
±2; 4 kV	HCP	A	B	Pass
±2; 4kV	VCP	A	B	Pass

12. CONTINUOUS RF ELECTROMAGNETIC FIELD DISTURBANCES

12.1. Test Specification

Test standard	: EN 55035	
Basic standard	: IEC 61000-4-3	
Performance criterion	: A	
Frequency range &	: <input checked="" type="checkbox"/> 80M-1000MHz	3V/m
Test level	: <input checked="" type="checkbox"/> Spot frequency	3V/m
	: <input type="checkbox"/> Additional spot frequency	3V/m
Modulation	: AM, 80%, 1kHz sine-wave	

12.2. Block Diagram of Test Setup

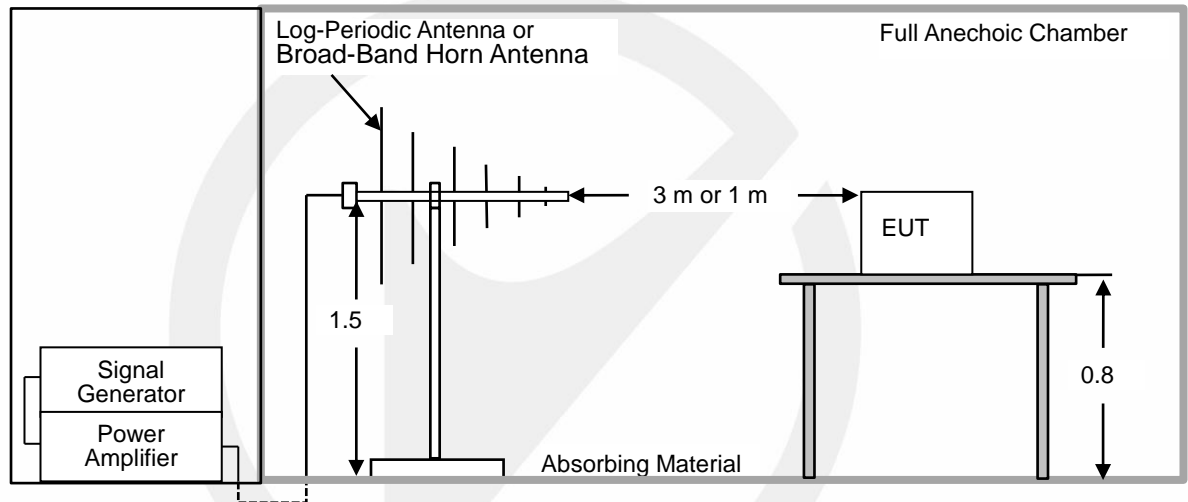

12.3. Test procedure

The procedure defined in this part requires the generation of electromagnetic fields within which the test sample is placed and its operation observed. To generate fields that are useful for simulation of actual (field) conditions may require significant antenna drive power and the resultant high field strength levels. To comply with local regulations and to prevent biological hazards to the testing personnel, it is recommended that these tests be carried out in a shielded enclosure or semi-anechoic chamber.

- a. The antenna which is enabling the complete frequency range of 80-1000 MHz is placed 3m (or 1m) away from the equipment. The required field strength is determined by placing the field strength meter(s) on top of or directly alongside the equipment under test and monitoring the field strength meter via a remote field strength indicator outside the enclosure while adjusting the continuous-wave to the antenna.
- b. The test is performed with the antenna facing the front and back sides of the EUT with. Both vertical and horizontal polarizations from antenna are tested.

12.4. Test results

Pass.

(The test was carried out at: EMTEK (SHENZHEN) CO., LTD)

Temperature : 21°C
 Humidity : 48 %
 Atmospheric Pressure : 101kpa
 Test Engineer : CSL
 Test Date : 2021-12-03

80M-1000MHZ:

Freq. Range (MHz)	Field	Modulation	Polarity	Position (°)	Actual criterion	Required performance criterion	Result
80-1000	3V/m	AM, 80%	H / V	0, 90,180, 270	A	A	Pass

Spot frequency:

Freq (MHz)	Field	Modulation	Polarity	Position (°)	Actual criterion	Required performance criterion	Result
1800, 2600, 3500, 5000	3V/m	AM, 80%	H / V	0, 90,180, 270	A	A	Pass

Additional spot frequency:

Freq (MHz)	Field	Modulation	Polarity	Position (°)	Actual criterion	Required performance criterion	Result
80, 120, 160, 230, 434, 460, 600, 863, 900	3V/m	AM, 80%	H / V	0, 90,180, 270	N/A	A	N/A

13. ELECTRICAL FAST TRANSIENTS/BURST

13.1. Test Specification

Test standard : EN 55035
 Basic standard : IEC 61000-4-4
 Performance criterion : B
 Test level : 1kV, AC mains power ports
 0.5kV, DC network power ports
 0.5kV, Analogue/digital data ports
 Repetition frequency : 5kHz, 100kHz(Only xDSL ports)
 Tr/Th: : 5/50ns
 Burst period : 300ms
 Test time : : 120s

13.2. Block Diagram of Test Setup

AC Lines:

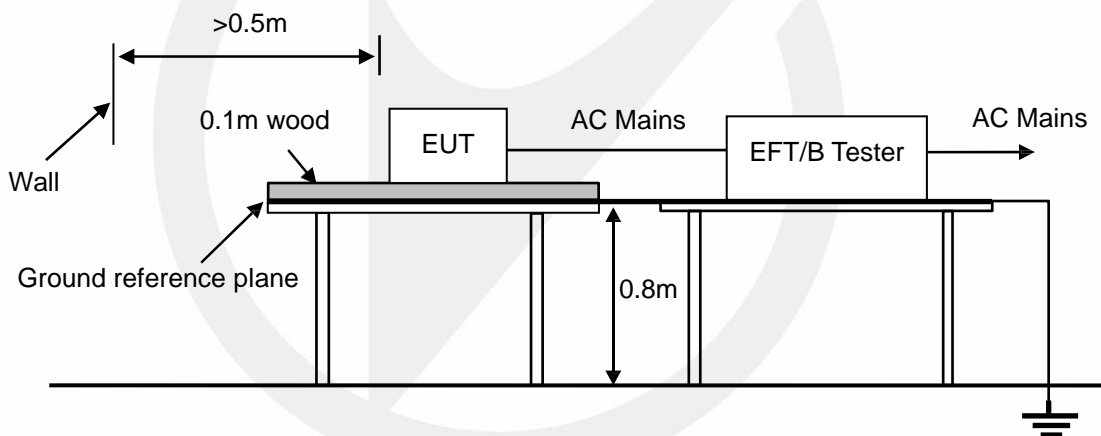

Signal lines:

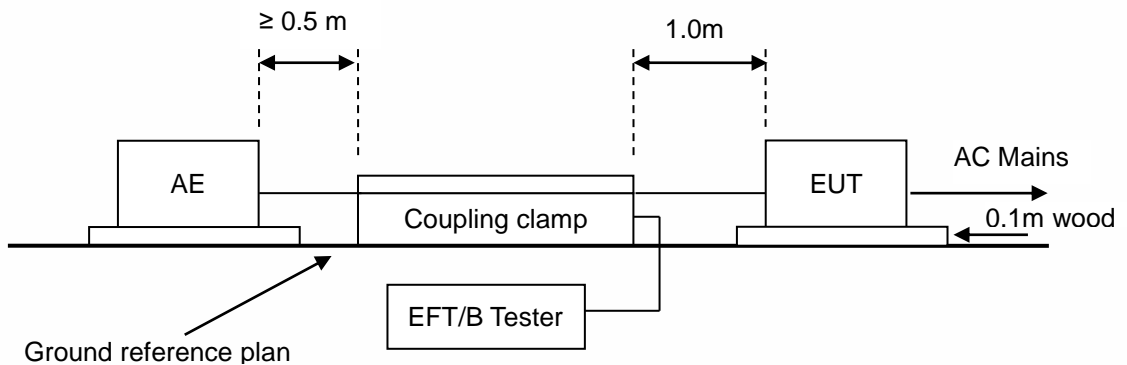

13.3. Test Procedure

The EUT is put on the table that is 0.8 meter high above the ground. This reference ground plane shall project beyond the EUT by at least 0.1m on all sides and the minimum distance between EUT and all other conductive structure, except the ground plane beneath the EUT, shall be more than 0.5m.

13.4. Test Results

Pass.

Temperature : 25 °C
 Humidity : 49 %
 Atmospheric Pressure : 101kpa
 Test Engineer : LSL
 Test Date : 2021-12-01

Injection Line	Voltage (kV)	Injected Method	Actual criterion	Required performance criterion	Result (Pass/Fail)
<input checked="" type="checkbox"/> AC mains power ports	± 1	<input type="checkbox"/> CDN <input checked="" type="checkbox"/> Direct injection <input type="checkbox"/> Capacitive coupling clamp	A	B	Pass
<input type="checkbox"/> DC network power ports	± 0.5	<input type="checkbox"/> CDN <input type="checkbox"/> Direct injection <input type="checkbox"/> Capacitive coupling clamp	N/A	B	N/A
<input checked="" type="checkbox"/> Analogue/digital data ports (Wired network port)	± 0.5	<input type="checkbox"/> CDN <input type="checkbox"/> Direct injection <input checked="" type="checkbox"/> Capacitive coupling clamp	A	B	Pass
<input type="checkbox"/> Analogue/digital data ports (Broadcast receiver tuner port)	± 0.5	<input type="checkbox"/> CDN <input type="checkbox"/> Direct injection <input type="checkbox"/> Capacitive coupling clamp	N/A	B	N/A
<input type="checkbox"/> Analogue/digital data ports (.....)	± 0.5	<input type="checkbox"/> CDN <input type="checkbox"/> Direct injection <input type="checkbox"/> Capacitive coupling clamp	N/A	B	N/A

14. SURGES

14.1. Test Specification

Test standard	:	EN 55035
Basic standard	:	IEC 61000-4-5
Test level	:	<input checked="" type="checkbox"/> 1kV, Line to Line, AC mains power ports, Criterion B <input type="checkbox"/> 2kV, Line to Earth, AC mains power ports, Criterion B <input type="checkbox"/> 0.5kV, Line to Reference ground, DC network power ports, Criterion B <input type="checkbox"/> 1.0kV, 4.0kV, Lines to Ground, Unshielded symmetrical, where primary protection is intended, Criterion C <input checked="" type="checkbox"/> 1.0kV, Lines to Ground, Unshielded symmetrical, where primary protection is not intended Criterion C <input type="checkbox"/> 0.5kV, Shield to ground, Coaxial or shielded port, Criterion B
Number of surges	:	5 (for each combination of parameters)
Repetition rate	:	1 minute / time
Polarity:	:	Positive / Negative
Phase angle:	:	90°, 270° (Only AC mains power ports)

14.2. Block Diagram of Test Setup

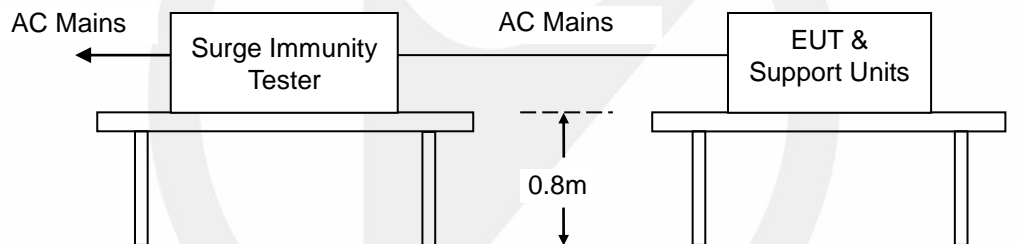

14.3. Test Procedure

This test simulates a lightning event by inducing transients onto the AC/DC power supply lines in common mode (Line to Ground) and differential mode (Line to Line). Each device was tested in a total of two surge configurations: Line to Ground (L-G): Combination Wave, Line to Protective Earth with 9uF and 10Ohm and Neutral to Protective Earth with 9uF and 10Ohm, common mode, generator earthed.

Line to Line (L-L): Combination Wave,

Line to Neutral with 18uF, differential mode, generator floated.

2 ohm : the source impedance of the low-voltage power supply network.

12 ohm : the source impedance of the low-voltage power supply network and ground.

- If not otherwise specified the surges have to be applied synchronized to the voltage phase at the zero-crossing and the peak value of the a.c. voltage wave (positive and negative).
- The surges have to be applied line to line and line to earth. When testing line to earth, the test voltage has to be applied successively between each of the lines and earth, if there is no other specification.
- The test procedure shall also consider the non-linear current-voltage characteristics of the equipment under test. Therefore the test voltage has to be increased by steps up to the test level specified in the product standard or test plan. All lower levels including the selected test level shall be satisfied.
- For testing the secondary protection, the output voltage of the generator shall be increased up to the worst-case voltage breakdown level (let-through level) of the primary protection.
- Testing shall be performed according to a Test Plan, which shall be included in the test report.
- To find all critical points of the duty cycle of the equipment, a sufficient number of positive and negative test pulses shall be applied.

14.4. Test results

Pass.

Temperature : 25 °C
 Humidity : 49 %
 Atmospheric Pressure : 101kpa
 Test Engineer : LSL
 Test Date : 2021-12-01

AC mains power ports:

Coupling Line	Voltage (kV)	Waveform (μs)	Polarity	Actual criterion	Required performance criterion	Result (Pass/Fail)
<input checked="" type="checkbox"/> Line to line	1	1.2/50 (8/20)	Pos./ Neg.	A	B	Pass
<input type="checkbox"/> Line to earth	2	1.2/50 (8/20)	Pos./ Neg.	N/A	B	N/A

DC network power ports:

Coupling Line	Voltage (kV)	Waveform (μs)	Polarity	Actual criterion	Required performance criterion	Result (Pass/Fail)
Line to Reference ground	0.5	1.2/50 (8/20)	Pos./ Neg.	N/A	B	N/A

Analogue/digital data ports:

Port type	Coupling Line	Voltage (kV)	Waveform (μs)	Polarity	Actual criterion	Required performance criterion	Result (Pass/Fail)
<input checked="" type="checkbox"/> Unshielded symmetrical (Wired network port)	Lines to ground	0.5, 1	10/700 (5/320)	Pos./ Neg.	A	C	Pass
<input type="checkbox"/> Unshielded symmetrical (.....)	Lines to ground	0.5, 1	10/700 (5/320)	Pos./ Neg.	N/A	C	N/A
<input type="checkbox"/> Unshielded symmetrical	Lines to ground	0.5, 1, 2, 4	10/700 (5/320)	Pos./ Neg.	N/A	C	N/A
<input type="checkbox"/> Coaxial or shielded (Broadcast receiver tuner port)	Shield to ground	0.5	1.2/50 (8/20)	Pos./ Neg.	N/A	B	N/A
<input type="checkbox"/> Coaxial or shielded (.....)	Shield to ground	0.5	1.2/50 (8/20)	Pos./ Neg.	N/A	B	N/A

15. CONTINUOUS INDUCED RF DISTURBANCES

15.1. Test Specification

Test standard	: EN 55035
Basic standard	: IEC 61000-4-6
Performance criterion	: A
Frequency range & Test level	: 0.15M to 10MHz, 3V 10M to 30MHz, 3V to 1V 30M to 80MHz, 1V
Modulation	: AM 80%, 1kHz sine-wave
Frequency Step	: 1% of fundamental

15.2. Block Diagram of Test Setup

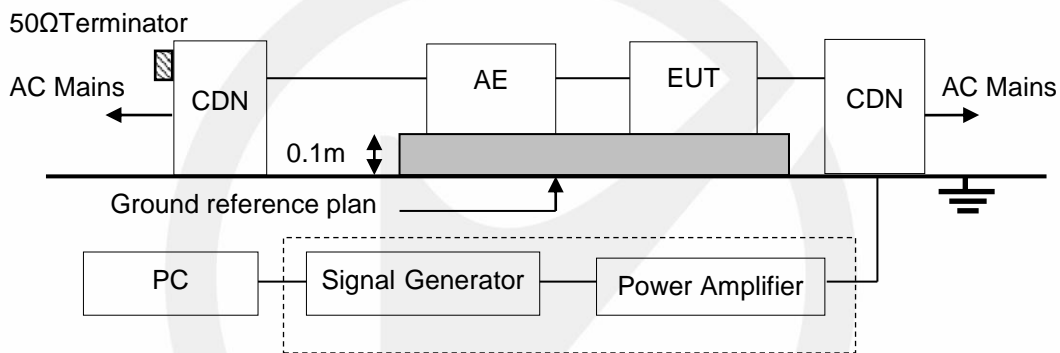

15.3. Test Procedure

- The EUT shall be operated within its intended climatic conditions. The temperature and relative humidity should be recorded.
- The EUT is placed on a 0.1m high test table, and a well grounded cable is connected to metallic plane above the test table.
- All cables/wires must be laid out on test plate (3cm in thickness), and the EUT is set up on test plate (10 cm in thickness) as shown in test setup photo, and the cables/wires must not be in mid-air, they should be touching the surface of test plate. Ensure that the EUT is properly connected to the accessory equipment.
- The test shall be performed with the test generator connected to each of the coupling and decoupling devices in turn while the other non-excited RF-input ports of the coupling devices are terminated by a 50 ohm load resistor.
- The frequency range is swept from 150 kHz to 80 MHz, using the signal levels established during the setting process, and with the disturbance signal 80% amplitude modulated with a 1 kHz sine wave, pausing to adjust the RF-signal level or to switch coupling devices as necessary. The rate of sweep shall no exceed 1.5×10^{-3} decades/s. Where the frequency is swept incrementally, the step size shall no exceed 1% of the start and thereafter 1% of the preceding frequency value.
- The dwell time at each frequency shall not be less than the time necessary for the EUT to be exercised, and able to respond. Sensitive frequencies e.g. clock frequency (ies) and harmonics or frequencies of dominant interest shall be analyzed separately.
- Attempts should be made to fully exercise the EUT during testing, and to fully interrogate all exercise modes selected for susceptibility
- Testing shall be performed according to a Test Plan, which shall be included in the test report.

15.4. Test results

Pass.

Temperature : 25 °C
 Humidity : 49 %
 Atmospheric Pressure : 101kpa
 Test Engineer : LSL
 Test Date : 2021-12-01

Range (MHz)	Levers (V)	Injection port	Coupling type	Actual criterion	Required performance criterion	Result (Pass/Fail)
0.15-10	3	<input checked="" type="checkbox"/> AC mains power ports	<input checked="" type="checkbox"/> CDN	A	A	Pass
10-30	3-1		<input type="checkbox"/> EM Clamp			
30-80	1		<input type="checkbox"/> Current Clamp <input type="checkbox"/> Direct injection			
0.15-10	3	<input type="checkbox"/> DC network power ports	<input type="checkbox"/> CDN	N/A	A	N/A
10-30	3-1		<input type="checkbox"/> EM Clamp			
30-80	1		<input type="checkbox"/> Current Clamp <input type="checkbox"/> Direct injection			
0.15-10	3	<input checked="" type="checkbox"/> Analogue/digital data ports (Wired network port)	<input type="checkbox"/> CDN	A	A	Pass
10-30	3-1		<input type="checkbox"/> EM Clamp			
30-80	1		<input checked="" type="checkbox"/> Current Clamp <input type="checkbox"/> Direct injection			
0.15-10	3	<input type="checkbox"/> Analogue/digital data ports (Broadcast receiver tuner port)	<input type="checkbox"/> CDN	N/A	A	N/A
10-30	3-1		<input type="checkbox"/> EM Clamp			
30-80	1		<input type="checkbox"/> Current Clamp <input type="checkbox"/> Direct injection			
0.15-10	3	<input type="checkbox"/> Analogue/digital data ports (.....)	<input type="checkbox"/> CDN	N/A	A	N/A
10-30	3-1		<input type="checkbox"/> EM Clamp			
30-80	1		<input type="checkbox"/> Current Clamp <input type="checkbox"/> Direct injection			

16. POWER FREQUENCY MAGNETIC FIELD

16.1. Test Specification

Test Standard	: EN 55035
Basic Standard	: IEC 61000-4-8
Performance criterion	: A
Test level	: 1A/m

16.2. Block Diagram of Test Setup

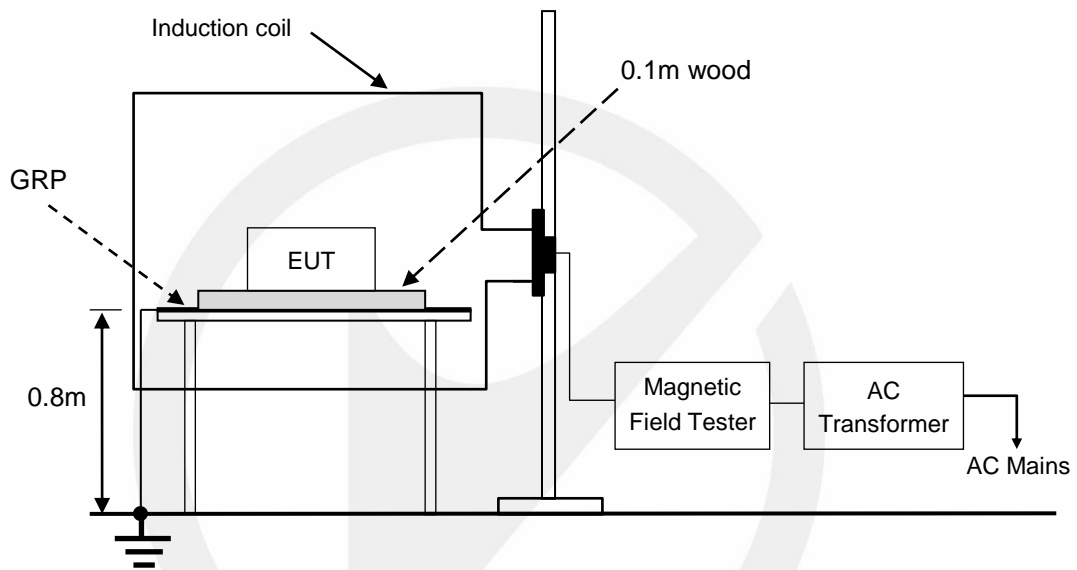

GRP: Ground reference plane
EUT: Equipment under test

16.3. Test Procedure

The EUT is placed in the middle of a induction coil (1*1m), under which is a 1*1*0.1m (high) table above the GRP, this small table is also placed on a larger table, 0.8 m above the ground. Both horizontal and vertical polarization of the induction coil is set on test, so that each side of the EUT is affected by the magnetic field. Also can reach the same aim by change the position of the EUT.

16.4. Test Results

N/A.

17. VOLTAGE DIPS AND INTERRUPTIONS

17.1. Test Specification

Test standard	:	EN 55035
Basic standard	:	IEC 61000-4-11
Test level	:	0%, 0.5 period, Criterion B
		<input checked="" type="checkbox"/> 70%, 25 periods for 50Hz, Criterion C
		<input checked="" type="checkbox"/> 70%, 30 periods for 60Hz, Criterion C
		<input checked="" type="checkbox"/> 0%, 250 periods for 50Hz, Criterion C
		<input checked="" type="checkbox"/> 0%, 300 periods for 60Hz, Criterion C

17.2. Block Diagram of Test Setup

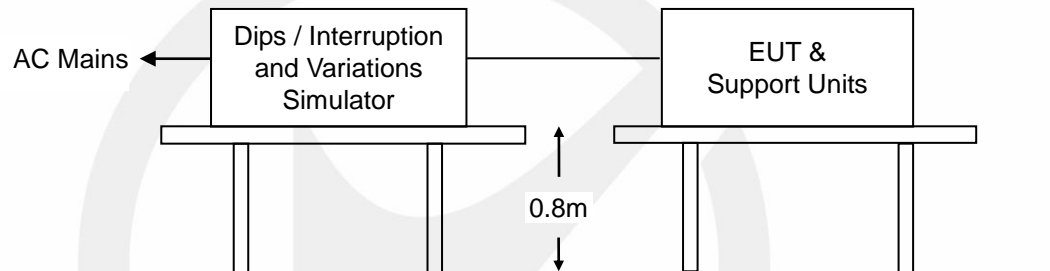

17.3. Test Procedure

- a. Where the equipment has a rated voltage the following shall apply - If the voltage range does not exceed 20% of the lower voltage specified for the rated voltage range, a single voltage within that range may be specified as a basis for test level specification.
 - In all other cases, the test procedure shall be applied for both the lowest and highest voltages declared in the voltage range.
- b. Test Conditions
 - Select operated voltage and frequency of EUT - Test of interval : 10 sec.
 - Level and duration : Sequence of 3 dips/interrupts.
 - Voltage rise (and fall) time : 1.5 μ s.

17.4. Test results

Pass.

Temperature : 25 °C
 Humidity : 49 %
 Atmospheric Pressure : 101kpa
 Test Engineer : LSL
 Test Date : 2021-12-01

Item	Test Level (% UT)	Phase angle (°)	Input Voltage (V)	Freq (Hz)	Duration (periods)	Actual criterion	Required performance criterion	Result (Pass /Fail)
<input checked="" type="checkbox"/> Voltage dips	0%	0°, 180°	AC 230V	50	0.5	A	B	Pass
<input checked="" type="checkbox"/> Voltage dips	0%	0°, 180°	AC 230V	60	0.5	A	B	Pass
<input checked="" type="checkbox"/> Voltage dips	70%	0°, 180°	AC 230V	50	25	A	C	Pass
<input checked="" type="checkbox"/> Voltage dips	70%	0°, 180°	AC 230V	60	30	A	C	Pass
<input checked="" type="checkbox"/> Voltage interruptions	0%	0°, 180°	AC 230V	50	250	B	C	Pass
<input checked="" type="checkbox"/> Voltage interruptions	0%	0°, 180°	AC 230V	60	300	B	C	Pass

18. PHOTOGRAPHS

18.1. Photo of Conducted Emission Measurement

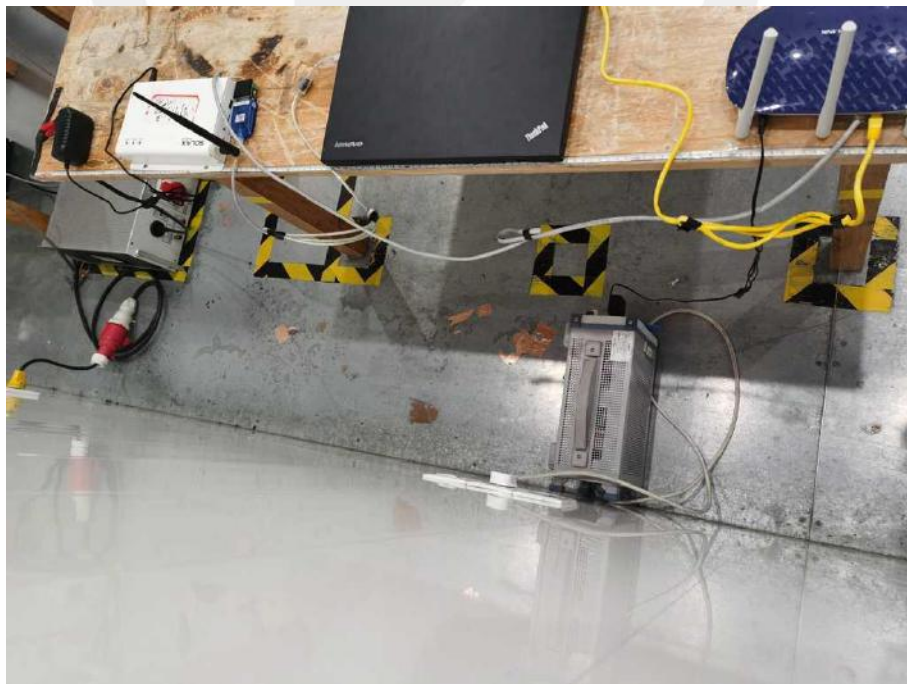

18.2. Photo of Conducted Emissions at Telecommunications/network port Measurement



18.3.Photo of Radiation Emission Measurement (Up to 1GHz)

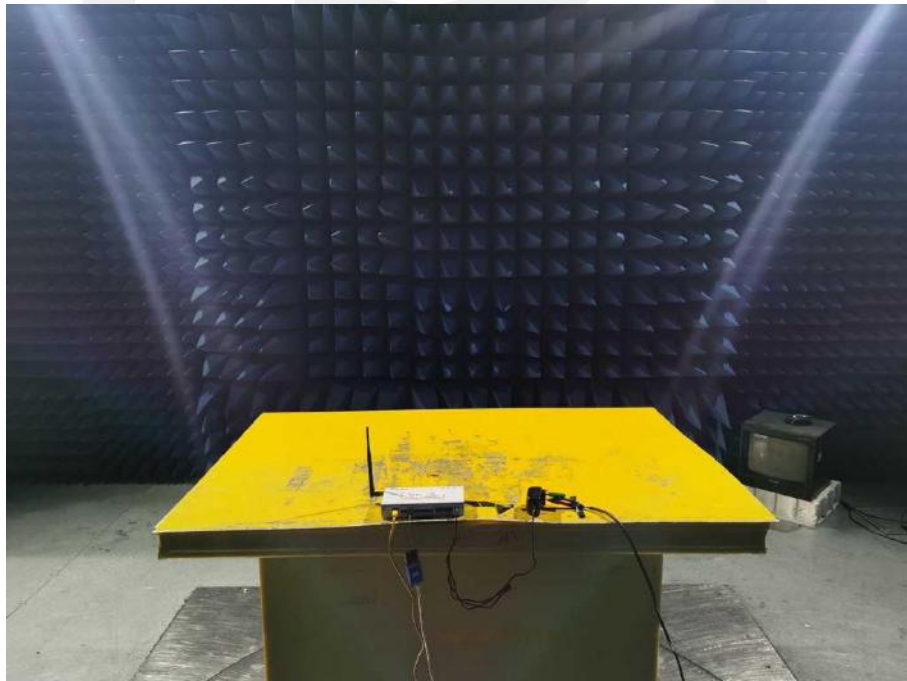
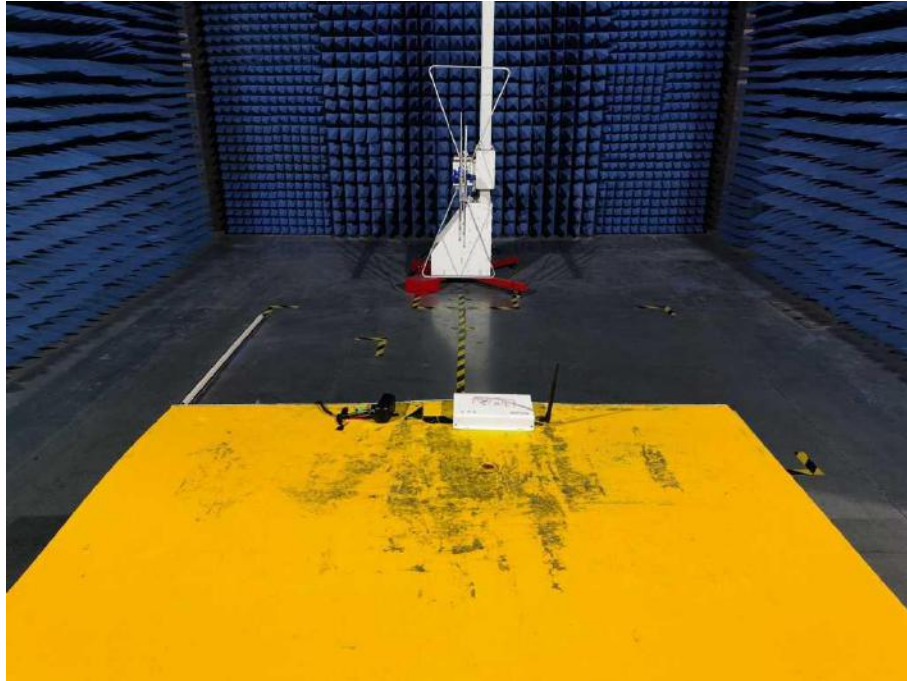

18.4.Photo of Radiation Emission Measurement (Above 1GHz)

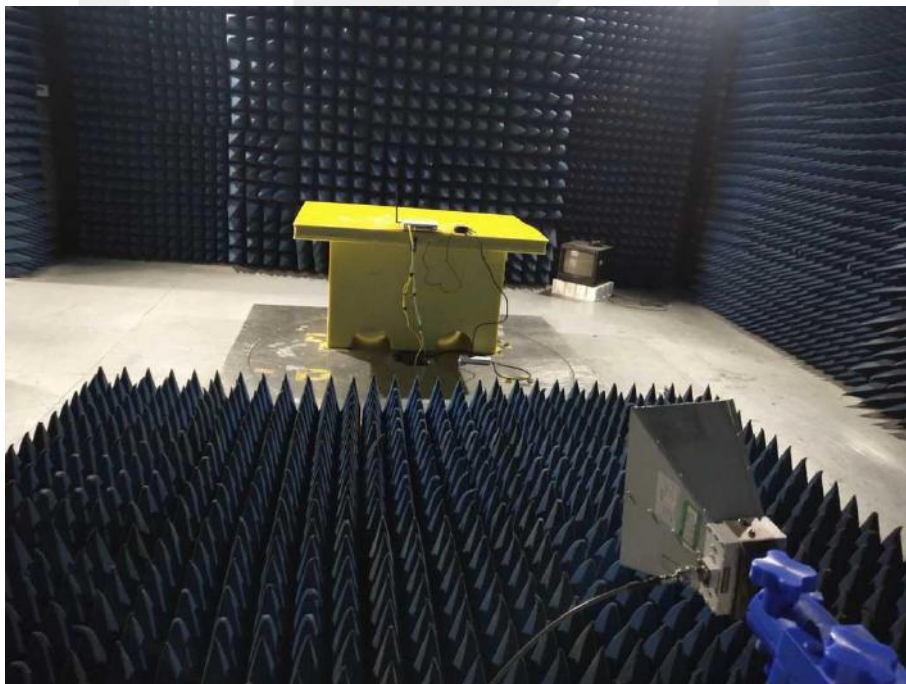
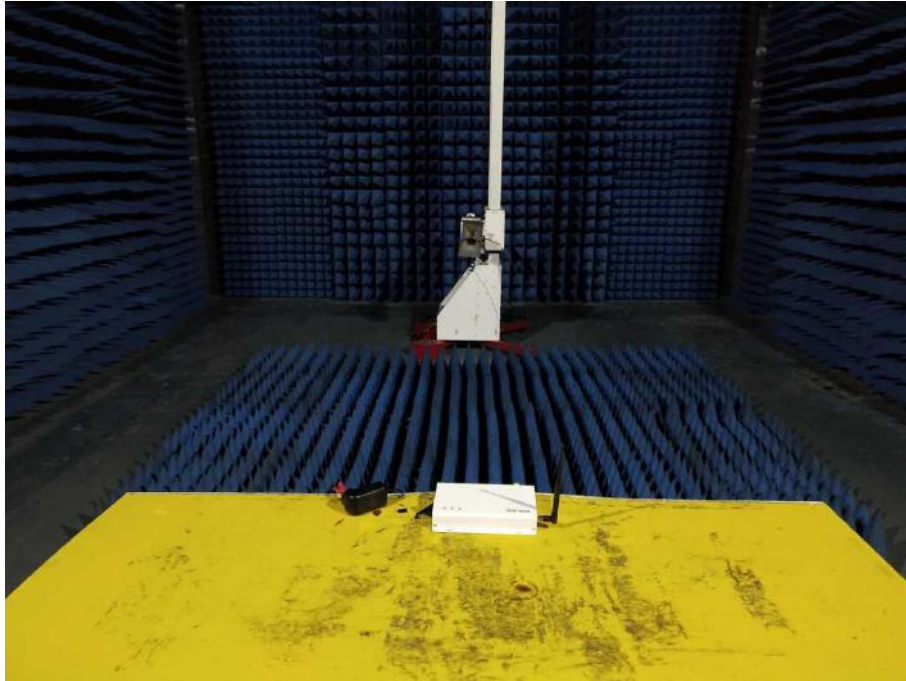

18.5.Photo of Harmonic and Flicker Measurement

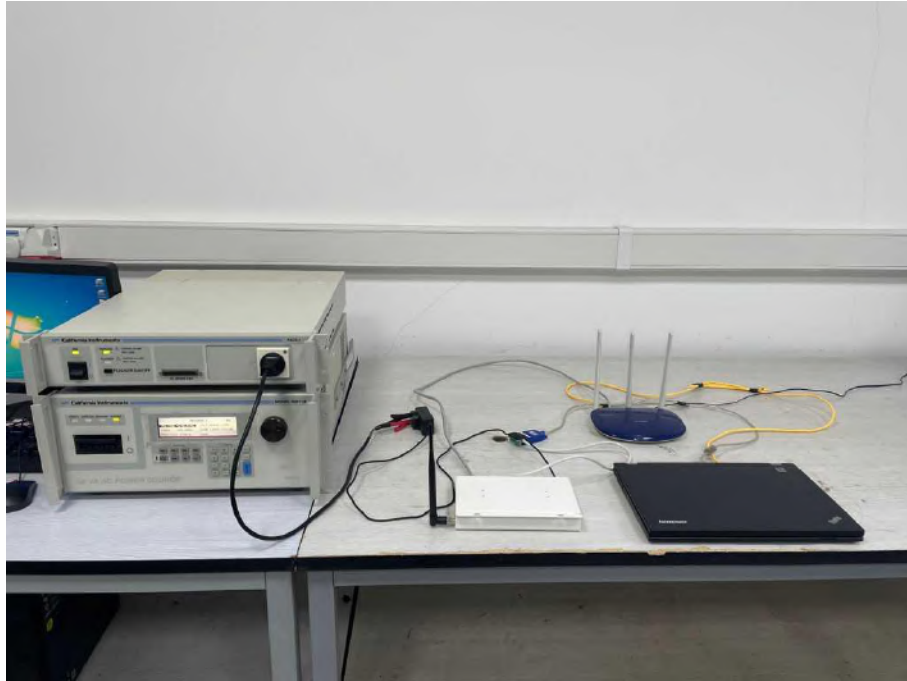

18.6.Photo of Electrostatic Discharge Test

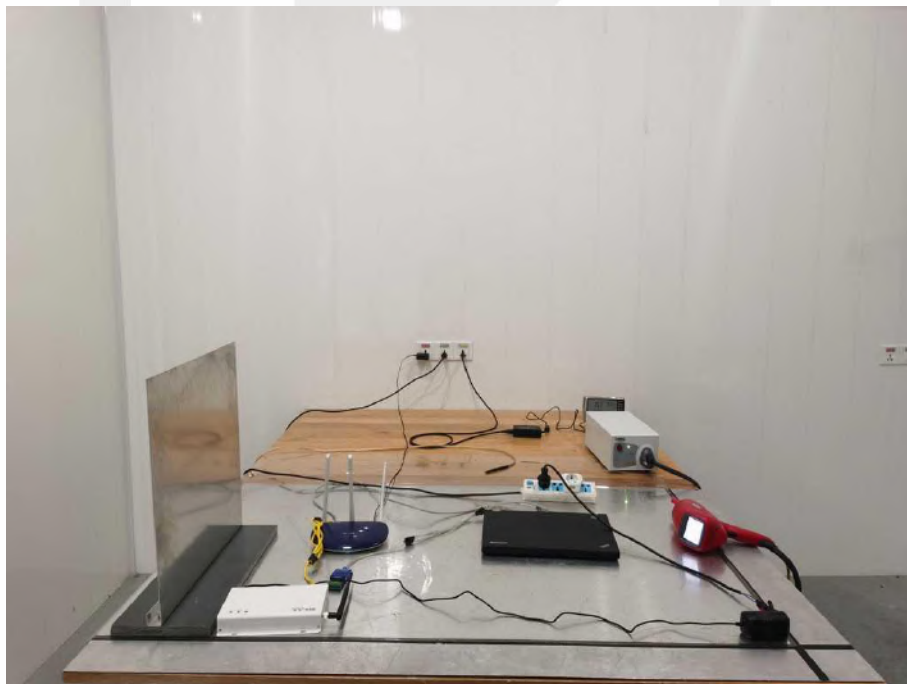

18.7.Photo of RF Field Strength Susceptibility Test

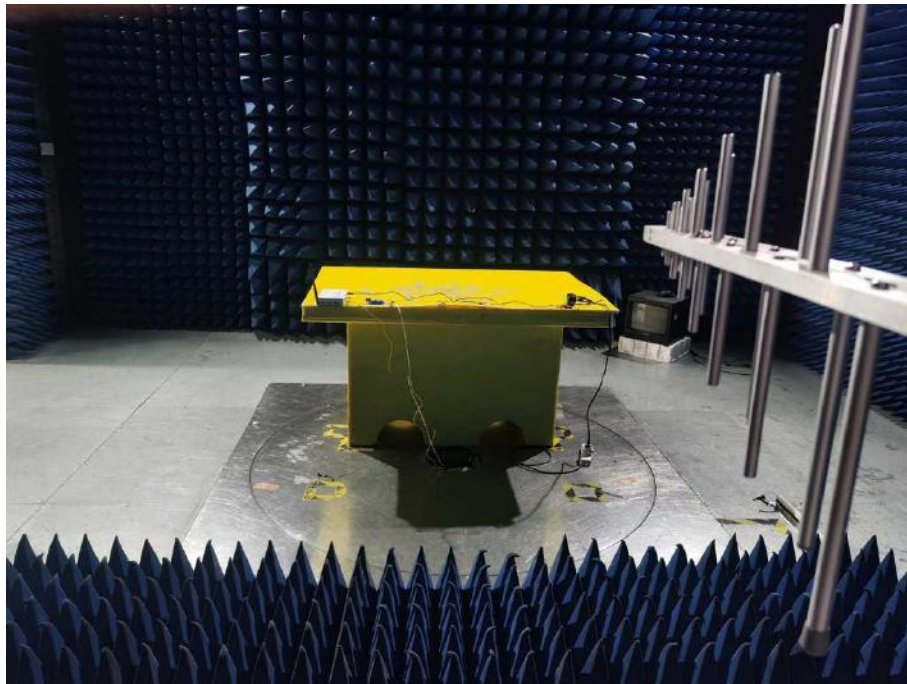

18.8.Photo of Electrical Fast Transient /Burst Test

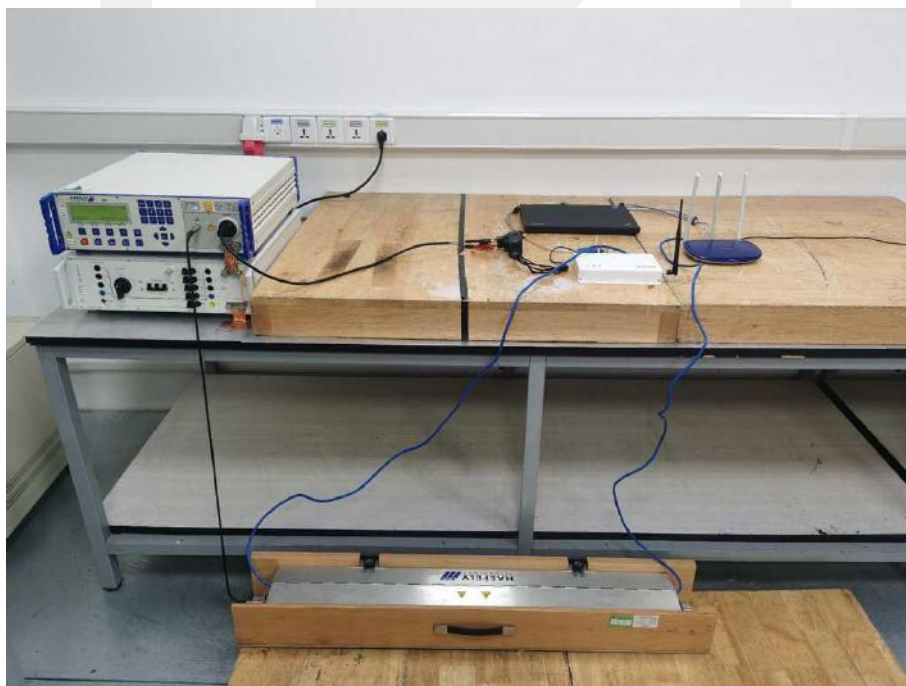

18.9.Photo of Surge Test



18.10.Photo of Injected Currents Susceptibility Test



18.11.Photo of Voltage Dips and Interruption Immunity Test





**APPENDIX
(PHOTOS OF EUT)**

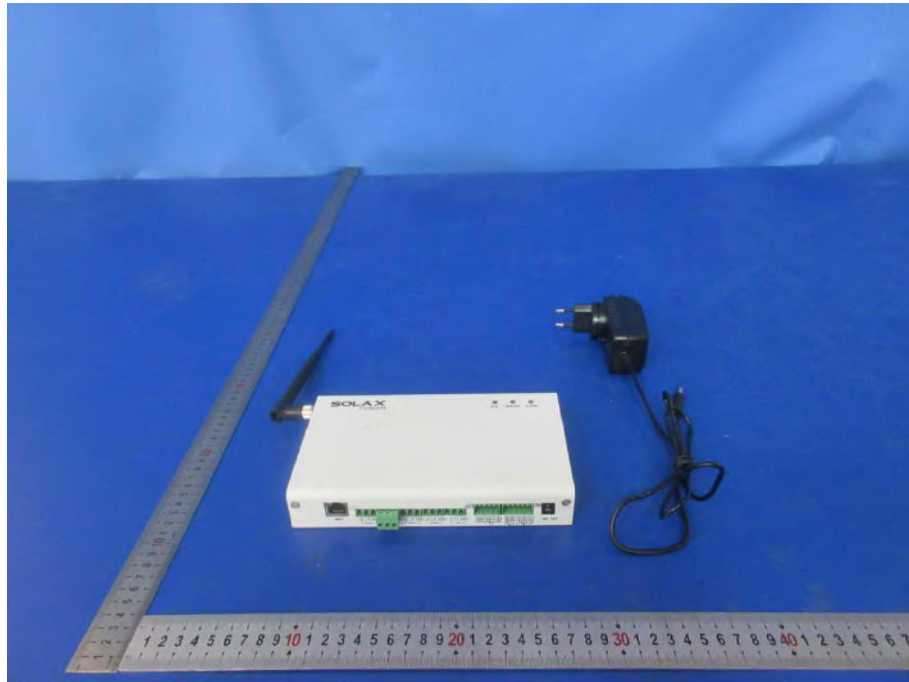

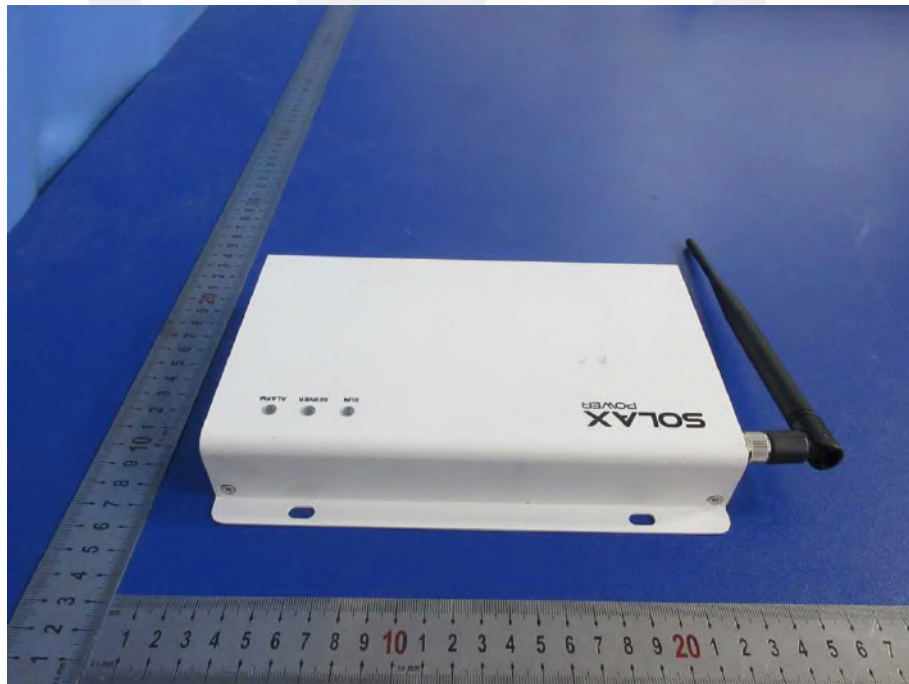

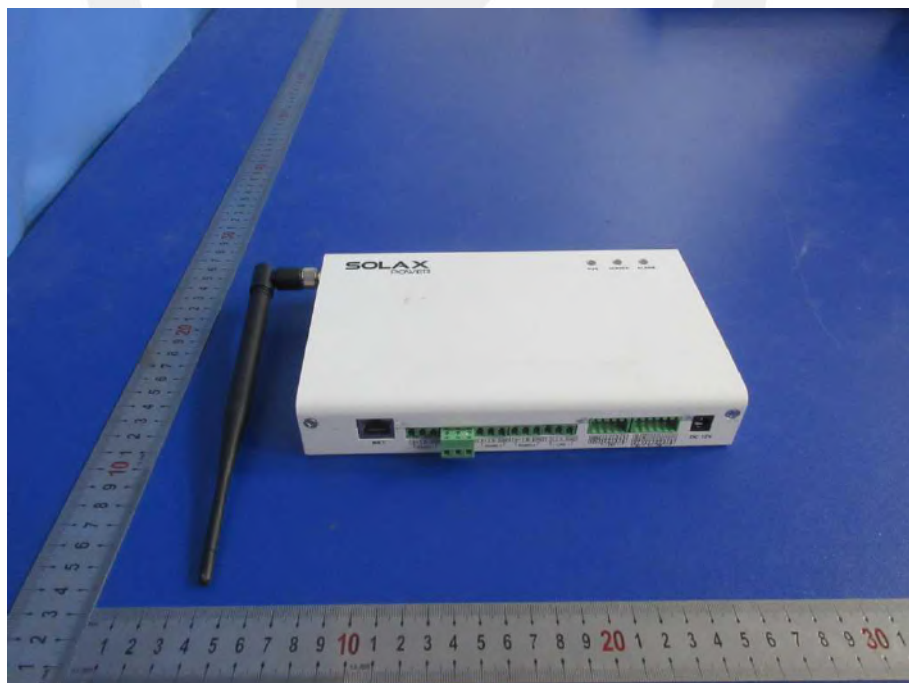

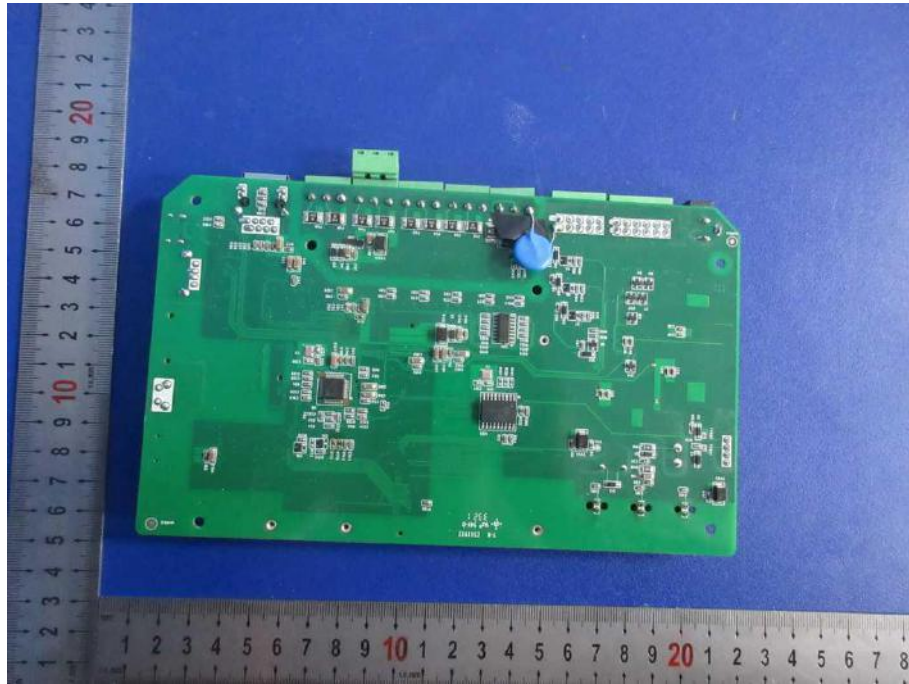

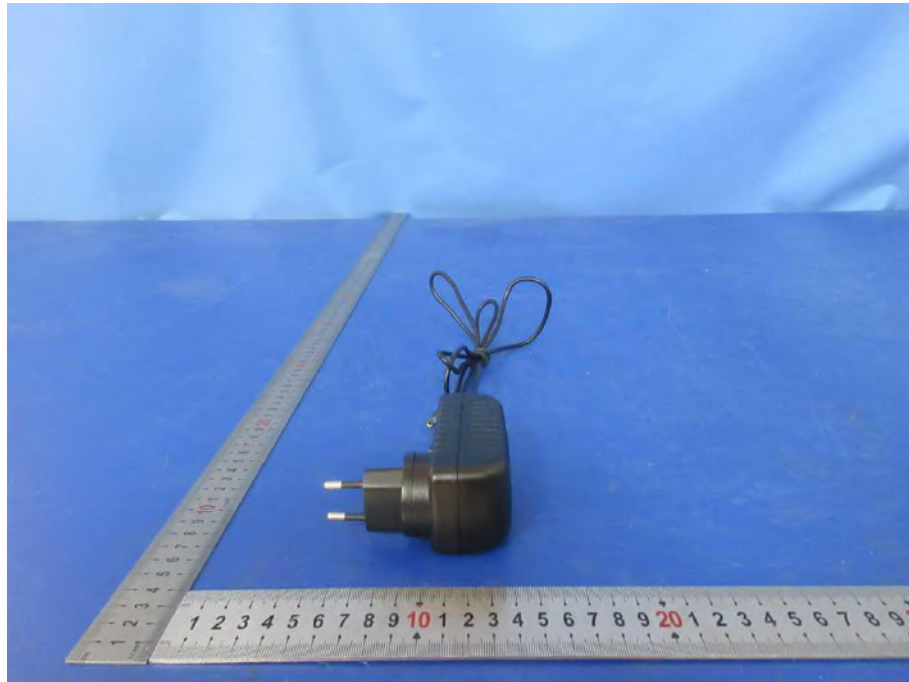

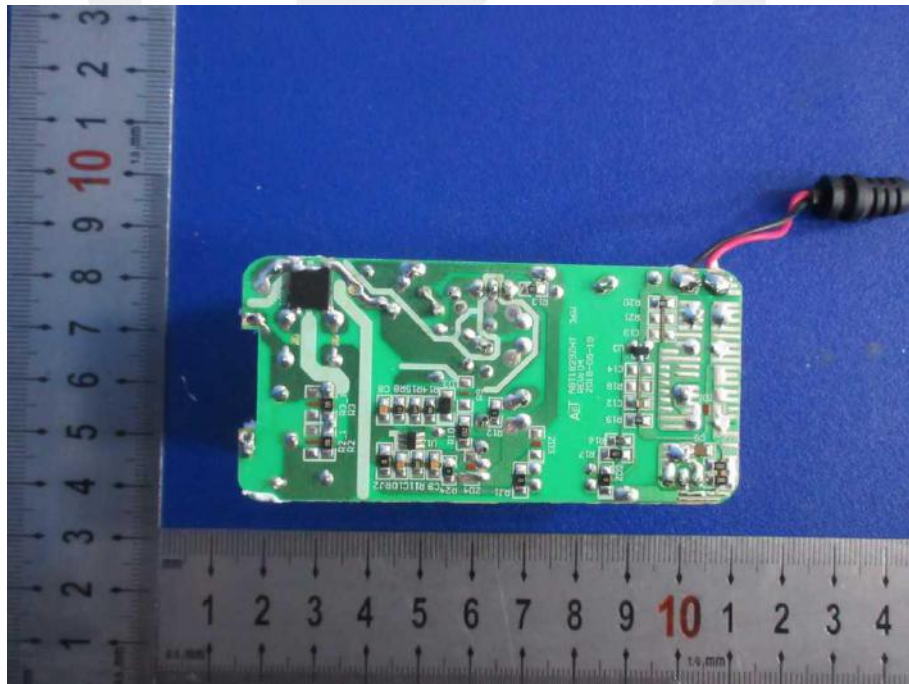



*** End of Report ***

声明 Statement

1. 本报告无授权批准人签字及“检验报告专用章”无效；
This report will be void without authorized signature or special seal for testing report.
2. 未经许可本报告不得部分复制；
This report shall not be copied partly without authorization.
3. 本报告的检测结果仅对送测样品有效，委托方对样品的代表性和资料的真实性负责；
The test results or observations are applicable only to tested sample. Client shall be responsible for representativeness of the sample and authenticity of the material.
4. 本检测报告中检测项目标注有特殊符号则该项目不在资质认定范围内，仅作为客户委托、科研、教学或内部质量控制等目的使用；
The observations or tests with special mark fall outside the scope of accreditation, and are only used for purpose of commission, research, training, internal quality control etc.
5. 本检测报告以实测值进行符合性判定，未考虑不确定度所带来的风险，本实验室不承担相关责任，特别约定、标准或规范中有明确规定的除外；
The test results or observations are provided in accordance with measured value, without taking risks caused by uncertainty into account. Without explicit stipulation in special agreements, standards or regulations, EMTEK shall not assume any responsibility.
6. 对本检测报告若有异议，请于收到报告之日起 20 日内提出；
Objections shall be raised within 20 days from the date receiving the report.